

Video Cassette Recorder

VRB412AT  
VRB612AT

## Owner's Manual

**Important!**  
Return your Warranty Registration  
Card within 10 days. See why inside.



# PHILIPS

# Return your Warranty Registration card today to ensure you receive all the benefits you're entitled to.

Once your PHILIPS purchase is registered, you're eligible to receive all the privileges of owning a PHILIPS product. So complete and return the Warranty Registration Card enclosed with your purchase at once. And take advantage of these important benefits.

## Warranty Verification

Registering your product within 10 days confirms your right to maximum protection under the terms and conditions of your PHILIPS warranty.

## Owner Confirmation

Your completed Warranty Registration Card serves as verification of ownership in the event of product theft or loss.

## Model Registration

Returning your Warranty Registration Card right away guarantees you'll receive all the information and special offers which you qualify for as the owner of your model.

# PHILIPS

*Congratulations on your purchase, and welcome to the "family!"*

### Dear PHILIPS product owner:

Thank you for your confidence in PHILIPS. You've selected one of the best-built, best-backed products available today. And we'll do everything in our power to keep you happy with your purchase for many years to come.

As a member of the PHILIPS "family," you're entitled to protection by one of the most comprehensive warranties and outstanding service networks in the industry.

What's more, your purchase guarantees you'll receive all the information and special offers for which you qualify, plus easy access to accessories from our convenient home shopping network.

And most importantly you can count on our uncompromising commitment to your total satisfaction.

All of this is our way of saying welcome-and thanks for investing in a PHILIPS product.

Sincerely,



Robert Minkhorst  
President and Chief Executive Officer

**P.S. Remember, to get the most from your PHILIPS product, you must return your Warranty Registration Card within 10 days. So please mail it to us right now!**



Know these **safety** symbols



**⚡** This "bolt of lightning" indicates uninsulated material within your unit may cause an electrical shock. For the safety of everyone in your household, please do not remove product covering.

**⚠** The "exclamation point" calls attention to features for which you should read the enclosed literature closely to prevent operating and maintenance problems.

**WARNING:** TO PREVENT FIRE OR SHOCK HAZARD, DO NOT EXPOSE THIS EQUIPMENT TO RAIN OR MOISTURE.

**CAUTION:** To prevent electric shock, match wide blade of plug to wide slot, fully insert.

**ATTENTION:** Pour éviter les choc électriques, introduire la lame la plus large de la fiche dans la borne correspondante de la prise et pousser jusqu'au fond.

### For Customer Use

Enter below the Serial No. which is located on the rear of the cabinet. Retain this information for future reference.

Model No. \_\_\_\_\_

Serial No. \_\_\_\_\_



# PHILIPS

Visit our World Wide Web Site at <http://www.philips.com>

## Welcome to your VCR owner's manual.

This manual describes the VRB412 and the VRB612. The VRB412 is a monaural (single sound source) system, while the VRB612 is a stereo system. Otherwise, the two models are exactly the same. In this manual, the VRB612 is illustrated. (The VRB412 has single AUDIO IN/OUT jacks. Otherwise, the VRB412 looks exactly like the VRB612.)

This manual has seven sections: Setting Up Your VCR; Description of Controls; Basic Operations; Recording; Playing; Additional Features; and Information You May Need. The instructions explain all of the VCR's features, which are listed below. You cannot hurt your VCR by trying the features! So read on – and relax.

### Features

- Automatic Channel Setup
- Automatic Clock Setting with Time Zone
- Automatic Head Cleaner
- Automatic Operation Features
- Automatic Tracking Adjustment
- Blue Background
- Daylight-Savings Time
- Display Panel
- Front Panel Menu Access
- Hi-Fi Stereo Sound System (VRB612 only)
- High Quality (HQ) System
- MTS (Multi-Channel Television Sound) System (VRB612 only)
- 19 micron head
- On-Screen Displays in English or Spanish
- One-Touch Recording
- Real-Time Counter
- Remote Control with capability to operate TV, Cable Box, and Direct Broadcast System
- Repeat Play
- S-VHS Quasi Play Back (SQPB)
- Special Effects Playback: Forward and Reverse Searching; Still; Slow Motion
- Time Search
- Timer Recording

### Safety Precautions

**Warning: To prevent fire or shock hazard, do not expose this equipment to rain or moisture.**

**Federal Communications Commission Warning: Any unauthorized changes or modifications to this equipment void the user's authority to operate it.**

This VCR is equipped with a High Quality (HQ) system and is compatible with existing Video Home System (VHS) equipment.

Philips Consumer Electronics Company recommends that you use only video cassette tapes which are labeled with the **VHS** mark.

The use of other tapes may result in poor picture quality and excessive deposits on the video heads, which may not be covered by the warranty if damage occurs.

**Note to the Cable TV System Installer:** This reminder is provided to call the Cable TV system installer's attention to Article 820-40 of the National Electrical Code, which provides guidelines for proper grounding – in particular, specifying that the cable ground shall be connected to the grounding system of the building, as close to the point of cable entry as possible.

### Declaration of Conformity

Model Number: VRB412AT/VRB612AT  
Trade Name: Philips  
Responsible Party: Philips Consumer Electronics  
P.O. Box 14810  
Knoxville, TN 37914-1810  
(865) 521-4316



As an ENERGY STAR® Partner, Philips Consumer Electronics Company has determined that this product meets the ENERGY STAR® guidelines for energy efficiency. ENERGY STAR® is a U.S. registered mark. Using products with the ENERGY STAR® label can save energy. Saving energy reduces air pollution and lowers utility bills.

Copyright 2000 Philips Consumer Electronics Company. All rights reserved.

### Helpful Hint

- *This manual, your new product, and the packaging contain materials that can be recycled and reused. Specialized companies can recycle your product to increase the amount of reusable materials and to minimize the amount that needs to be properly disposed. Your product uses batteries that should not be thrown away when depleted but should be disposed of as small chemical waste. Please find out about the local regulations on disposal of your old product, batteries, manual, and packaging whenever you replace existing equipment.*

## 4 Table of Contents

---

### Setting Up Your VCR

Introduction	3
Table of Contents	4
Before Using Your VCR	5
Hookups without a Cable Box/Direct Broadcast System	6-7
Hookups with a Cable Box/Direct Broadcast System	8-9
Hookups with a Stereo TV	10
Turning on Your VCR	11
Automatic Channel Setup	12-14
Setting the Clock	15-18
Daylight-Savings Time	19
Language Selection	20
Setting the Remote to Operate a TV	21
Setting the Remote to Operate a Cable Box/Direct Broadcast System	22

### Description of Controls

Remote Control Buttons	23-24
On-Screen Status Displays	25
VCR Display Panel	26
Front Panel	27
Rear Panel	28

### Basic Operations

Playing	29
Recording	30

### Recording

Recording One Channel/Watching Another	31
One-Touch Recording	32
Timer Recording	33-36
Rerecording (Tape Duplication)	37

### Playing

Repeat Play	38
Real-Time Counter Memory	39
Time Search	40
Special Effects Playback	41
Automatic Operation Features	42

### Additional Features

Multi-Channel Television Sound System (VRB612 only)	43-44
Hi-Fi Stereo Sound System (VRB612 only)	45
Blue Background	46

### Information You May Need

Helpful Hints	47-48
Glossary	49
Specifications	50
Limited Warranty	51
Index	52
Accessories	56

## Before Using Your VCR 5

### Removing the Plastic Cover from the Front Panel

A thin, plastic cover may protect the front panel of your VCR. Before using the VCR, lift a corner of the plastic, then peel it off.

### Putting Batteries in the Remote Control

1

Remove the battery compartment lid on the bottom of the remote control by sliding it in the direction of the arrow.

2

Place two AA batteries inside the battery compartment with their + and – ends aligned as indicated.

3

Replace the battery compartment lid.

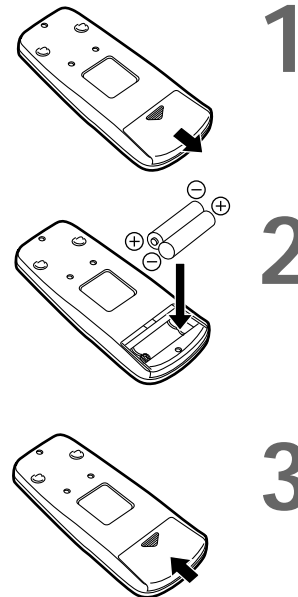

### Using the Remote Control

- Point the remote control at the VCR, then press the VCR button when using the remote control to operate the VCR.
- Point the remote control at the TV, then press the TV button when using the remote control to operate the TV.
- Point the remote control at the Cable Box or Direct Broadcast System (DBS), then press the CBL/DBS button when using the remote control to operate the Cable Box or DBS.

### Recording Prevention

Video cassette tapes have record tabs to ensure that recordings are not accidentally erased.

1

To prevent recording, break off the tab with a screwdriver.

2

To allow recording, cover the hole with cellophane tape.

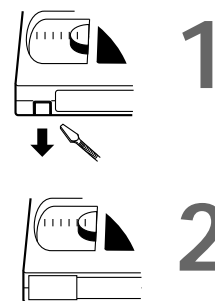

### VCR maintenance

- Use only tapes with the **VHS** mark.
- Remove any light adhesive stick-on notes from the video cassette tape before putting the tape in the VCR. Removable labels can jam the VCR.
- Periodic maintenance is required to maintain your VCR's excellent performance. This VCR has an Automatic Head Cleaner. However, the video heads will require replacement eventually. Only an authorized service center should perform this service.

#### Helpful Hints

- Do not mix alkaline and manganese batteries.
- Do not mix old and new batteries.

## 6 Hookups without a Cable Box/Direct Broadcast System

The basic VCR/TV connection – antenna/cable to VCR to TV – is shown below. If you have a Cable Box or a Direct Broadcast System, please see pages eight-nine. If you have a Stereo TV, please see page 10. After you hook up the VCR, go to page 11 to turn on the VCR. (The VRB612 is illustrated here. The VRB412 has single AUDIO IN/OUT jacks.)

# 1

Disconnect the antenna or cable from your TV.

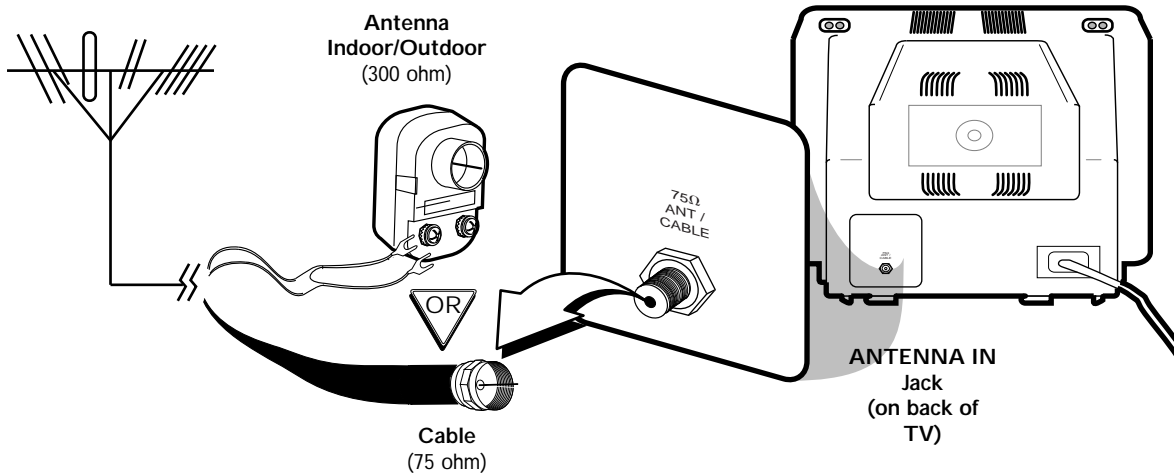

# 2

Connect the antenna or cable to the ANT(enna) IN Jack of your VCR.

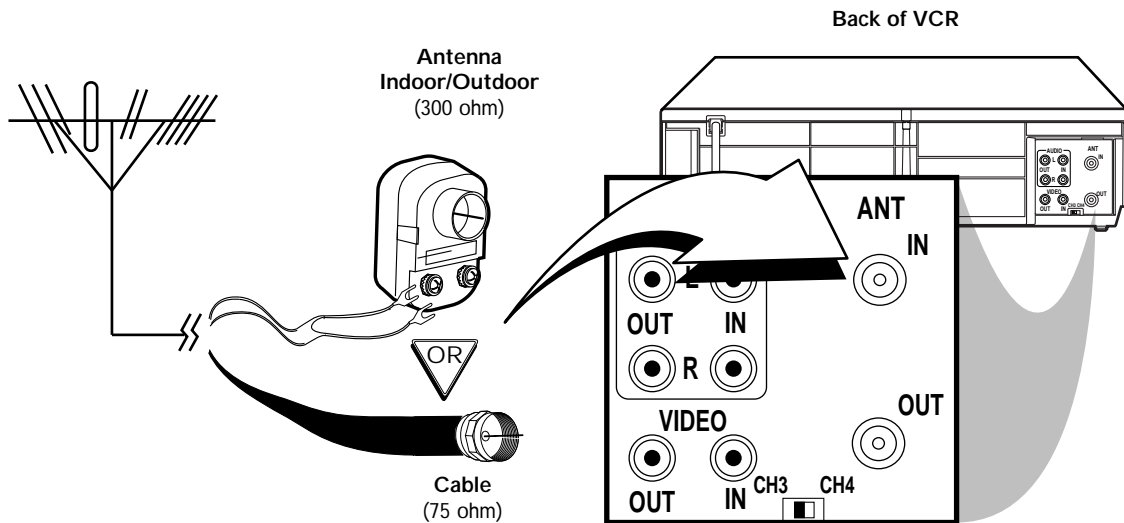

## Hookups without a Cable Box/Direct Broadcast System (cont'd) 7

### 3

Connect the RF coaxial cable (supplied) to the **OUT** Jack on the back of the VCR and to the **ANTENNA IN** Jack on the TV. (You may use either a snap-on type (supplied) or screw-on type of coaxial cable, whichever you prefer.)

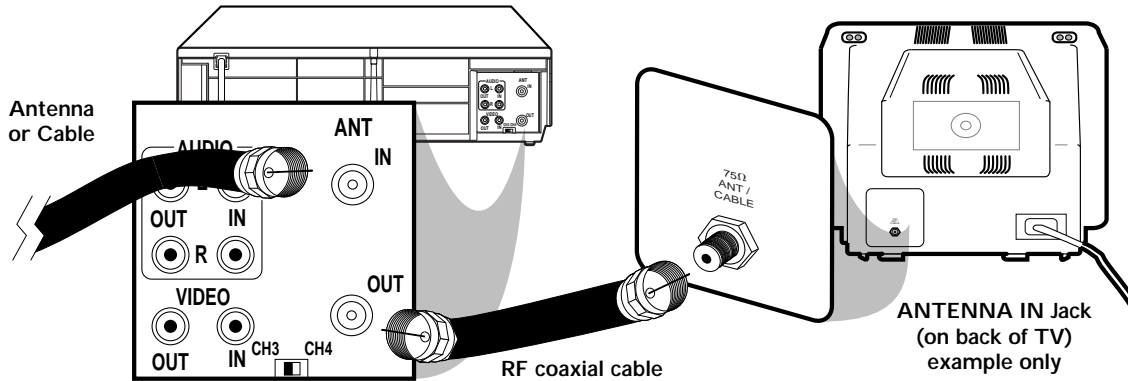

### 4

Plug in the TV and the VCR.

### 5

Set the **CH3/CH4** switch on the back of the VCR to **CH3** or **CH4**, whichever channel is not used or least used in your area. **Set the TV to the same channel.** For example, when playing a tape, if the CH3/CH4 switch is set to CH3, the TV should be on channel 03.

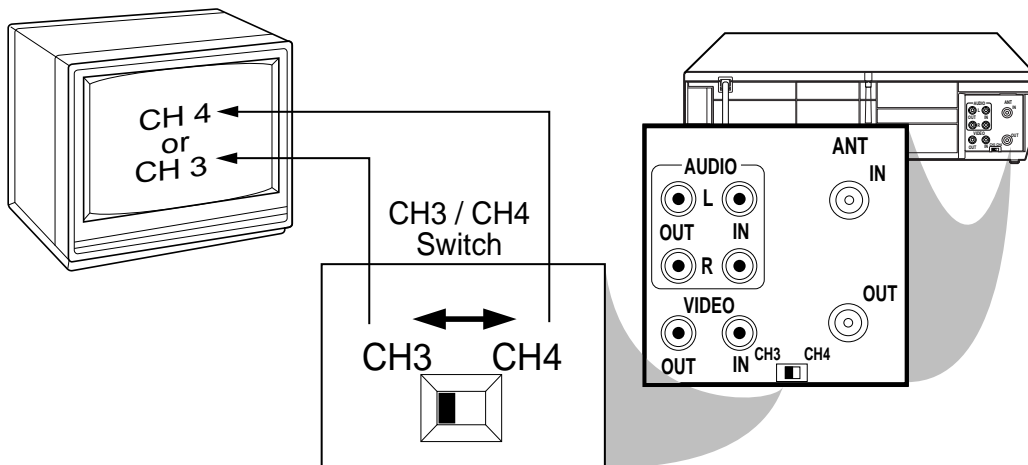

### 6

You are ready to turn on the VCR. Please go to page 11 before turning on the VCR.

## 8 Hookups with a Cable Box/Direct Broadcast System

---

There are two ways to connect your Cable Box/DBS to the VCR. With this connection:

- You may view any channel.
- You must select channels at the Cable Box/DBS. Channels cannot be changed at the VCR.
- You may not view a channel other than the one you are recording.
- You may not program channels at the VCR.
- You can only program a timer recording for one channel at a time. Set the TV and the VCR to the Cable Box/DBS output channel (channel 03 or 04). Set the CH3/CH4 switch to the same channel. Set your Cable Box/DBS to the channel you want to record. When you enter the channel you want to record in a timer recording, select channel 03 or 04 (the Cable Box/DBS output channel). (This is step 5 on page 34.) Leave the Cable Box/DBS on for a timer recording.

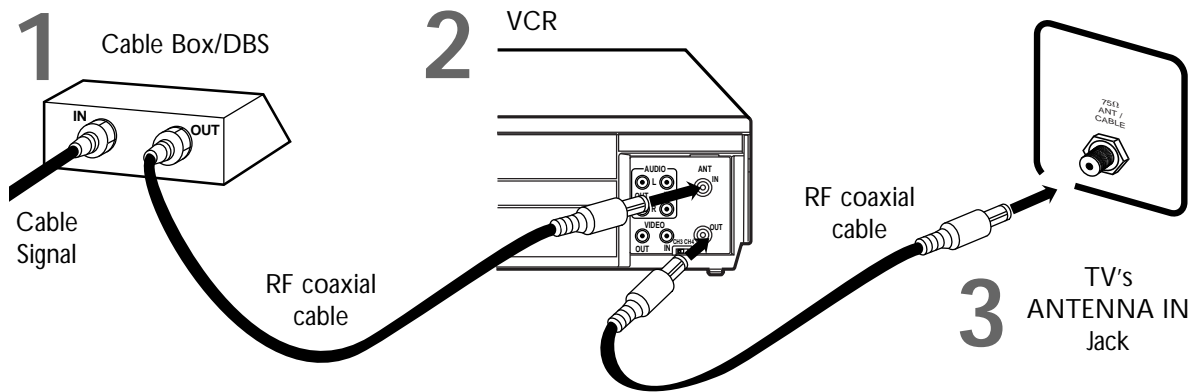

### Connections

**1**

Connect a Cable signal to the IN Jack on the Cable Box/DBS.

**2**

Use an RF coaxial cable (supplied) to connect the OUT Jack on the Cable Box/DBS to the ANT(enna) IN Jack on the VCR.

**3**

Use a second RF coaxial cable to connect the OUT Jack on the VCR to the TV's ANTENNA IN Jack.

### Recording/Viewing Any Channel

**1**

With the VCR on and in VCR position (the VCR light will appear on the display panel), set the VCR to the Cable Box/DBS output channel (03 or 04).

**2**

Set the TV to the same channel to which you set the VCR. Set the CH3/CH4 switch on the VCR to the same channel.

**3**

Select the channel you want to view/record at the Cable Box/DBS.



## Hookups with a Cable Box/Direct Broadcast System (cont'd) 9

With this connection:

- You may watch one channel while recording another.
- You may not record scrambled channels.

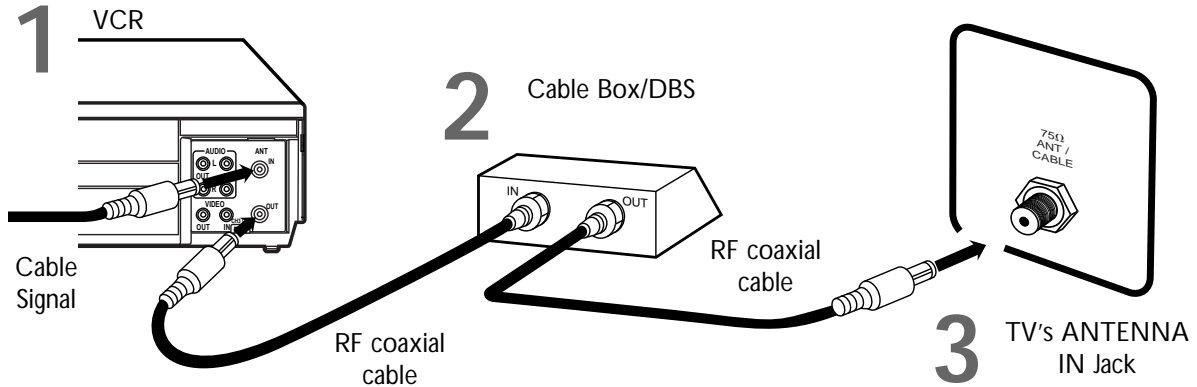

### Connections

1

Connect a Cable signal to the VCR's ANT(enna) IN Jack.

2

Use an RF coaxial cable (supplied) to connect the OUT Jack on the VCR to the IN Jack on the Cable Box/DBS.

3

Use a second RF coaxial cable to connect the OUT Jack on the Cable Box/DBS to the ANTENNA IN Jack on the TV.

### Recording One Channel/Watching Another

1

Put the Cable Box/DBS on the same channel as the VCR's CH3/CH4 switch. Set the TV to the Cable Box/DBS output channel (03 or 04). Then, with the VCR in VCR position (the VCR light will appear on the display panel), use the **CH(annel) ▲/▼** button to select the channel you want to record at the VCR. Start the recording.

2

Press the **VCR/TV** button once to put the VCR in TV position. (The VCR light will disappear.)

3

Select the channel you want to watch at the Cable Box/DBS.

4

To return to the channel you are recording, set the Cable Box/DBS to the same channel as the VCR's CH3/CH4 switch. Press the **VCR/TV** button so that the VCR is in VCR position again. The VCR light will appear on the display panel. The channel you are recording will appear on the screen. Press the **STOP/▼** button to stop recording.

#### Helpful Hint

- When you play a tape, make sure the Cable Box/DBS is set to the same channel as the CH3/CH4 switch on the VCR. Set the TV to the Cable Box/DBS output channel (03 or 04).

## 10 Hookups with a Stereo TV

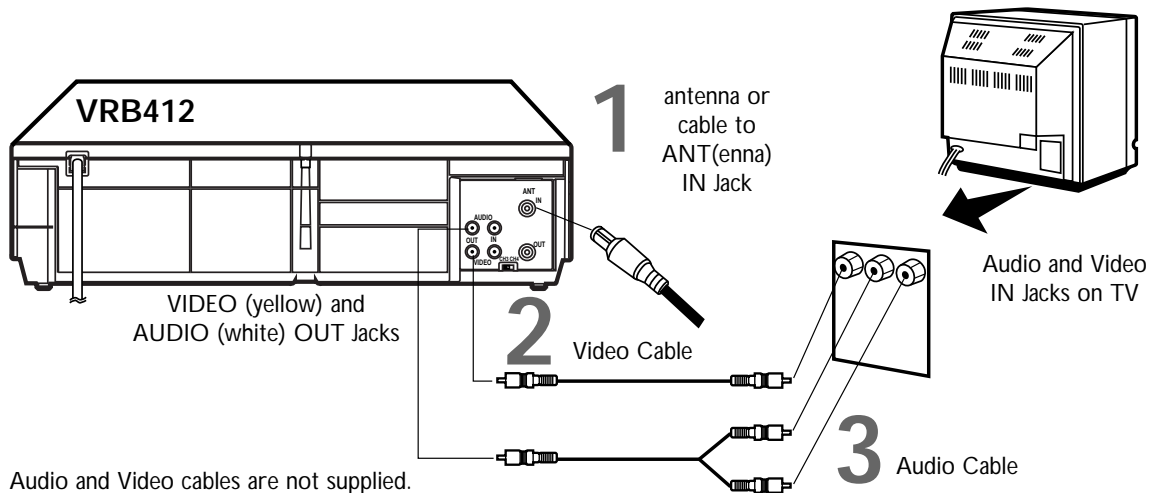
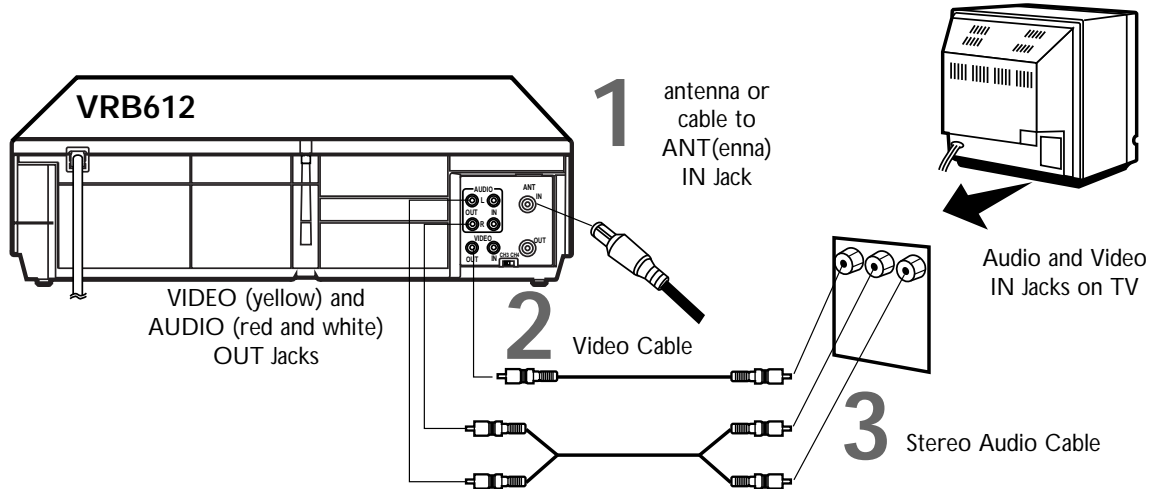

- Audio and Video cables are not supplied.

**1**

Connect the antenna or cable to the ANT(enna) IN Jack on the back of the VCR.

**2**

Connect a video cable to the yellow VIDEO OUT Jack on the back of the VCR. Then, connect the other end of the video cable to the VIDEO IN Jack on your TV.

**3**

**VRB612**

Connect a stereo audio cable to the red and white AUDIO OUT Jacks on the back of the VCR. Then, connect the other end of the audio cable to the AUDIO IN Jacks on your TV.

**3**

**VRB412**

Connect an audio cable to the white AUDIO OUT Jack on the back of the VCR. Then, connect the other end of the audio cable to the AUDIO IN Jack on your TV.

(If your TV has Right and Left AUDIO IN Jacks, you must use a "Y" splitter audio cable as illustrated to deliver audio to the TV's right and left channels.) This hookup will not give you stereo sound. To get stereo sound, use the connections on pages six - seven and select the channel to be viewed at the TV (with the VCR turned off).

**4**

Turn on your TV, making sure it is in Line Input mode. Please refer to your TV owner's manual for details.

## Turning on Your VCR 11

Before turning on your VCR, make sure there are batteries in the remote control and the VCR and TV are connected correctly.

- You can not program channels if you are using a Cable Box or a Direct Broadcast System.
- If you are not using a Cable Box/DBS, the clock may set itself automatically after you connect the antenna/Cable signal to the VCR and plug in the power cord. The time will appear on the display panel.

# 1

Press the **VCR** button, then press the **POWER** button. The VCR light and the PWR. (power) light will appear on the display panel.

# 2

Turn on the TV. Set it to the same channel as the **CH3/CH4** switch on the back of the VCR. The display shown below will appear. (If the display does not appear, check your hookups, then follow the steps on page 12 to set up channels and page 20 to select a language.)

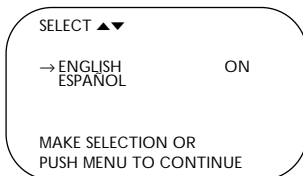

# 3

Within 60 seconds, press the **PLAY/▲** button or the **STOP/▼** button to select English or Spanish on-screen displays and menus.

# 4

Press the **MENU** button. The display shown below will appear.

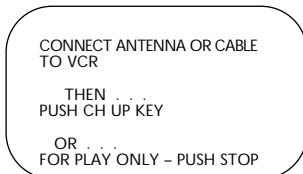

# 5

Within 60 seconds, press the **CH(annel) ▲** button to begin automatic channel programming. **AUTO CH PROGRAMMING IN PROCESS PLEASE WAIT** will appear on the screen. The VCR will memorize all available channels. The channel numbers will appear on the display panel as the VCR scans channels. When all channels are memorized, **CHANNELS ARE SET** will appear on the screen briefly, then TV programming will appear. Now, when you press the **CH(annel) ▲/▼** button, you'll only scan through channels that you receive.

# 2

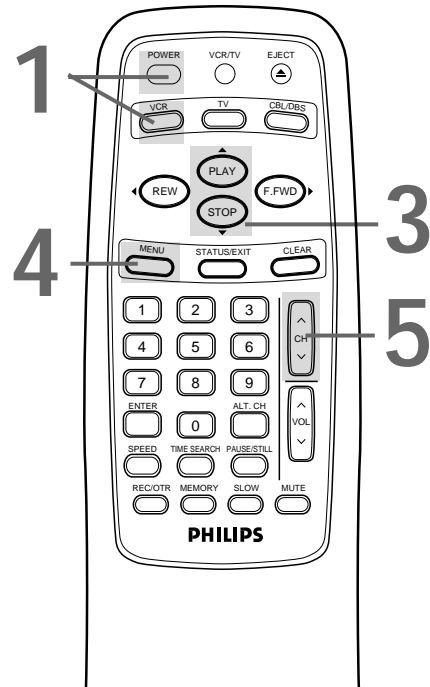
 Turn on the TV.

### Helpful Hints

- To skip this feature and play a tape immediately, insert a tape with its record tab removed. Or, to skip step 3, press the **MENU** button. All on-screen displays will be in English. To skip step 5, press the **STOP/▼** button. Channels will not be programmed, and **CHANNELS NOT SET** will appear on the screen.
- When you turn on the VCR again later, you may see a message regarding **AUTO CLOCK**. Details are on pages 15-18.
- If you try to program channels when there is no antenna or cable connected to the VCR, programming will appear to take place, but eventually a **NO TV SIGNALS** message will appear. Connect an antenna or cable to the VCR's **ANT(enna) IN Jack** and press the **CH(annel) ▲** button again. You may need to follow the steps on page 12.
- You may need to repeat the steps on this page if a power failure occurs.

## 12 Automatic Channel Setup

Although your VCR may automatically memorize the channels you receive when you turn it on for the first time, this function lets you set up the channels again.

# 1

Press the **VCR** button.

# 2

Press the **MENU** button.

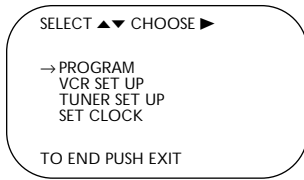

# 3

Press the **PLAY/▲** button or the **STOP/▼** button to select **TUNER SET UP**, then press the **F.FWD/►** button.

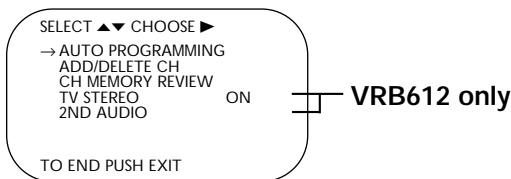

# 4

Press the **PLAY/▲** button or the **STOP/▼** button to select **AUTO PROGRAMMING**, then press the **F.FWD/►** button. The VCR distinguishes between TV channels and cable channels, and the VCR will memorize all the channels you receive.

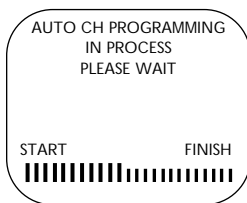

# 5

Wait for a few minutes while the VCR sets up the channels. When this is complete, CHANNELS ARE SET will appear on the screen. Then the programming of the lowest channel number placed in the VCR's memory will appear on the screen. Now when you press the CH(annel) ▲/▼ button, you will scan only through channels you receive.

# 3-4

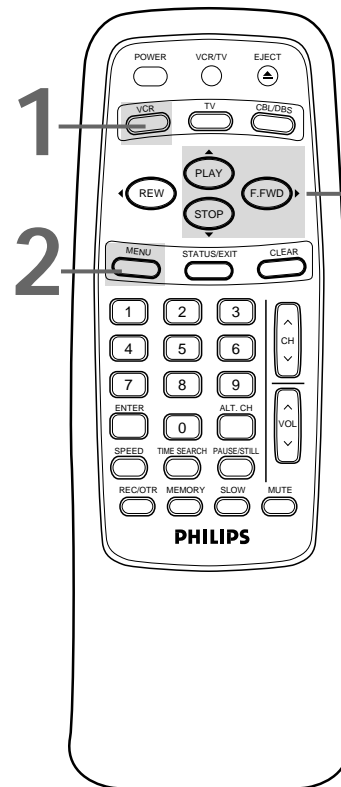

### Helpful Hints

- You can not enter the TUNER SET UP menu when you are in Line Input mode (channel 001 or 002). When you select channel 001 or 002, AV REAR or AV FRONT will appear on the screen briefly.
- You can not program channels if you are using a Cable Box or DBS.
- If you have an antenna, channels 2-69 will be available. If you have a cable connection, channels 1-125 will be available.

## Automatic Channel Setup (cont'd) 13

### Adding/Deleting Channels

1

Press the VCR button.

2

Press the MENU button.

3

Press the PLAY/▲ button or the STOP/▼ button to select TUNER SET UP, then press the F.FWD/▶ button.

4

Press the PLAY/▲ button or the STOP/▼ button to select ADD/DELETE CH, then press the F.FWD/▶ button.

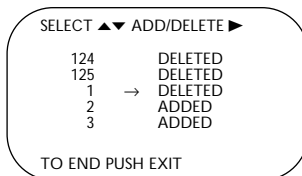

*NOTE: If you have an antenna, channel numbers 2-69 will appear on the ADD/DELETE CH menu. If you have a cable connection, channels 1-125 will be available.*

5

Press the PLAY/▲ button or the STOP/▼ button until the channel number you want to add or delete appears beside the arrow.

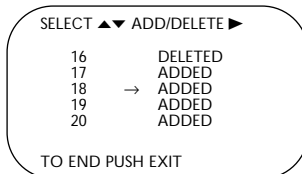

6

Press the F.FWD/▶ button to select ADDED or DELETED. Repeat steps 5 and 6 until you have added or deleted all the channels you wanted to add or delete.

7

Press the STATUS/EXIT button.

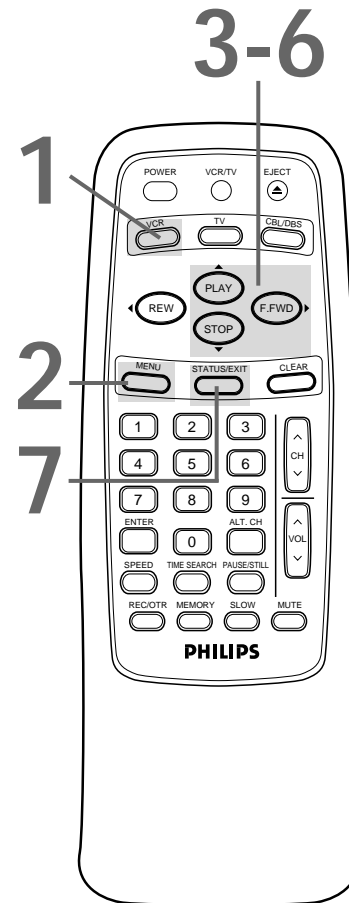

## 14 Automatic Channel Setup (cont'd)

### Reviewing Memorized Channels

1

Press the VCR button.

2

Press the MENU button.

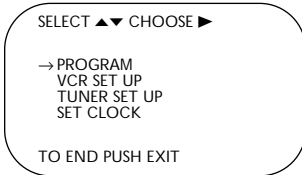

3

Press the PLAY/▲ button or the STOP/▼ button to select TUNER SET UP, then press the F.FWD/► button.

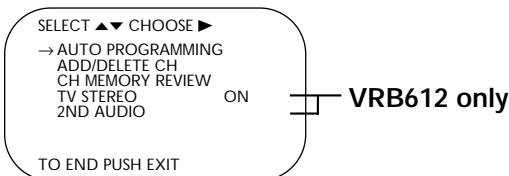

4

Press the PLAY/▲ button or the STOP/▼ button to select CH MEMORY REVIEW, then press the F.FWD/► button. A list of programmed channels will appear on the screen.

- If all the programmed channels don't fit on the screen, press the F.FWD/► button to see the remaining channels. Then press the REW(ind)/◀ button to return to the first screen of channels.
- If you do not press any buttons within 10 seconds, you will either go to the next screen of channels or you will return to the previous menu.

5

Press the STATUS/EXIT button once or twice to exit.

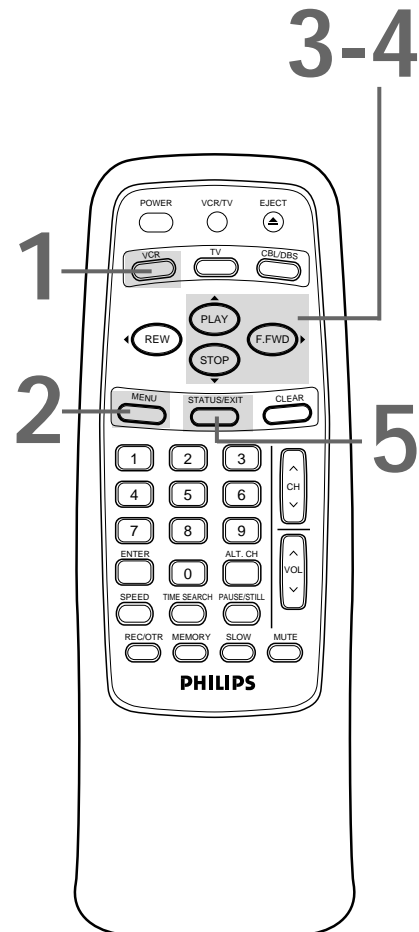

## Setting the Clock 15

There are two ways to set the clock. With manual clock setting, you tell the VCR the current time. With automatic clock setting, the VCR gets the current time from your local PBS station. It keeps track of the time by constantly referring to the time broadcasted by your PBS station.

**If you are using a Cable Box or Direct Broadcast System, you must set the clock manually.**

Follow the instructions under either manual clock setting or automatic clock setting (page 17) to set the VCR's clock. Before you begin, make sure:

- The VCR is hooked up and turned on, and channels are programmed into the VCR's memory (see pages six-12).
- The VCR is in VCR position. The VCR light will appear on the display panel. If it does not, press the VCR/TV button once.

Do each step within 60 seconds of the previous step.

### Manual Clock Setting

# 1

Press the VCR button.

# 2

Press the MENU button.

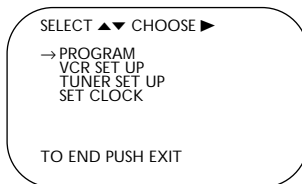

# 3

Press the PLAY/▲ button or the STOP/▼ button to select SET CLOCK, then press the F.FWD/▶ button.

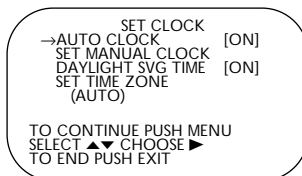

# 4

Press the PLAY/▲ button or the STOP/▼ button to select SET MANUAL CLOCK, then press the F.FWD/▶ button.

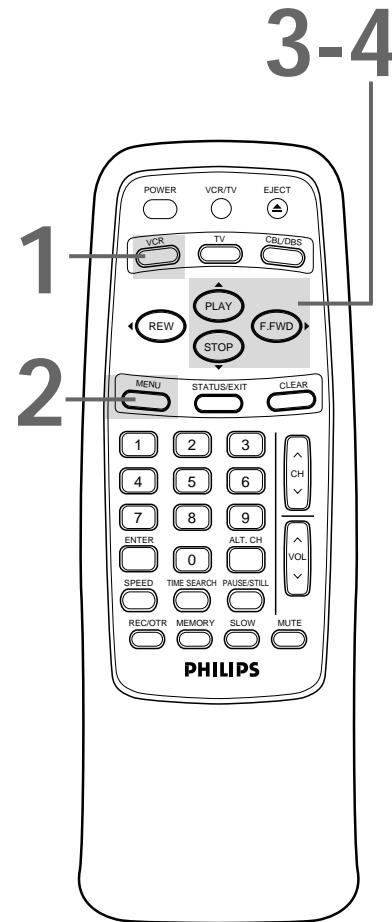
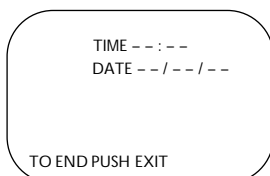

### Helpful Hints

- To display the time on the TV screen, press the STATUS/EXIT button. Details are on page 25.
- Power failures that last for more than one minute can cause you to lose your clock setting if you set the clock manually. If this happens, reset the clock.

## 16 Setting the Clock (cont'd)

# 5

Press two Number buttons for the hour(s) and two Number buttons for the minute(s). Then press 1 for AM or 2 for PM. For example, for 2:15 PM, press 02, 15, 2.

- Enter a 0 before a single-digit number.
- Entries that do not match the VCR's internal calendar or clock will cause a question mark (?) to appear on the screen.
- To make corrections, press the CLEAR button until the space for the number you want to correct is flashing. Then enter the correct number.

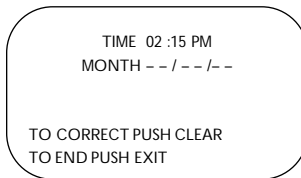

# 6

Press two Number buttons for the month, two Number buttons for the day, and two Number buttons for the year. For example, for July 1, 2000, press 07, 01, 00. The day of the week will appear automatically.

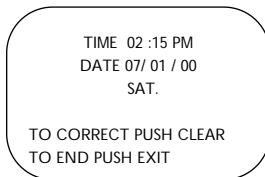

# 7

Press the STATUS/EXIT button to start the clock. The screen will return to the program you were watching. The time will appear on the VCR display panel.

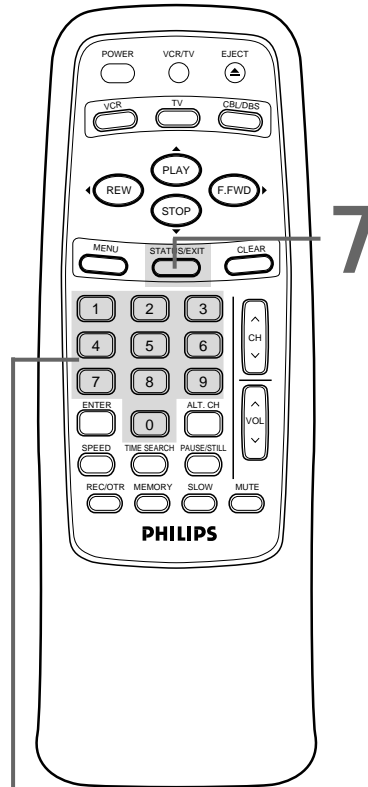

# 5-6



## Setting the Clock (cont'd) 17

### Automatic Clock Setting

# 1

Press the VCR button, then press the MENU button.

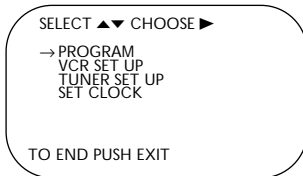

# 2

Press the PLAY/▲ button or the STOP/▼ button to select SET CLOCK, then press the F.FWD/► button.

# 3

If OFF appears to the right of AUTO CLOCK, press the F.FWD/► button to select ON. Then, press the MENU button. Or, if ON appears to the right of AUTO CLOCK, press the MENU button. Go to step 4.

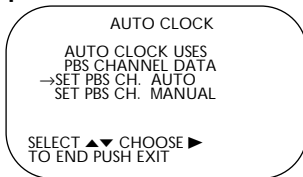

# 4

- If you want the VCR to locate a local PBS station from which to take the time, press the PLAY/▲ button or the STOP/▼ button to select SET PBS CH. AUTO. Then press the F.FWD/► button. When the current time appears on the screen, you're finished. Press the STATUS/EXIT button. Or, you may be prompted to turn off the VCR. Turn off the VCR power, and leave it off for several minutes. When the current time appears on the VCR display panel, the clock is set. You may turn on the VCR again.
- If you want to tell the VCR the PBS station from which to take the time, press the PLAY/▲ button or the STOP/▼ button to select SET PBS CH. MANUAL. Press the F.FWD/► button, then use the Number buttons to enter the channel number of the desired PBS station. When the current time appears on the screen, you're finished. Press the STATUS/EXIT button.  
*NOTE: CANNOT FIND PBS CLOCK DATA may flash on the screen. Press the PLAY/▲ button or the STOP/▼ button to choose SELECT NEW PBS CH., then press the F.FWD/► button. Use the Number buttons to enter the channel number of another PBS station. Or, press the PLAY/▲ button or the STOP/▼ button to select SET PBS CH. AUTO. Press the F.FWD/► button. You will be prompted to turn off the VCR. Turn off the VCR power, and leave it off for several minutes. When the current time appears on the VCR display panel, the clock is set. You may turn on the VCR again.*

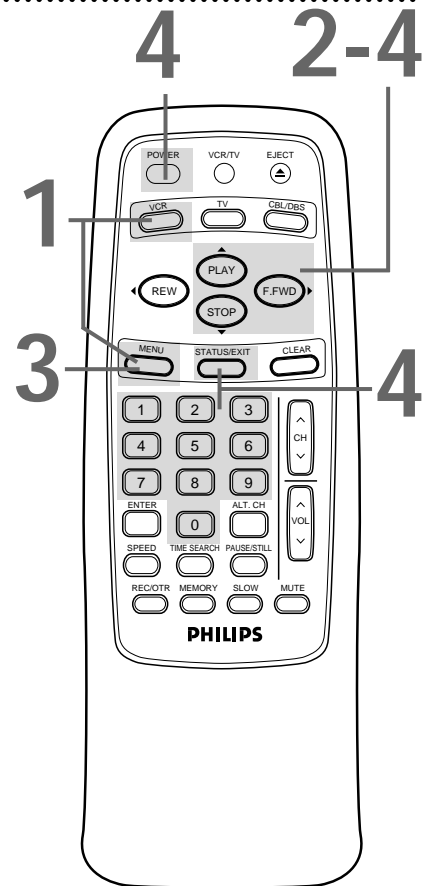

### Helpful Hints

- If you enter an incorrect PBS channel number at step 4, press the CLEAR button to erase the incorrect channel, then enter the correct channel number.
- If you have an antenna, you may select channels 2-69 at step 4. If you have a cable connection, you may select channels 1-125.
- The clock cannot be set automatically if you don't receive a channel that carries a time signal in your area. Set the clock manually.
- If there are only a few channels in your area that carry time signals, setting the clock automatically may take several minutes. If nothing happens even after you wait several minutes, set the clock manually.
- You cannot select AUTO CLOCK at step 3 during tape playback.

## 18 Setting the Clock (cont'd)

### Time Zone

When using the AUTO CLOCK function, you can specify your time zone. That way, the VCR will update the clock according to your time zone.

# 1

Press the VCR button, then press the MENU button.

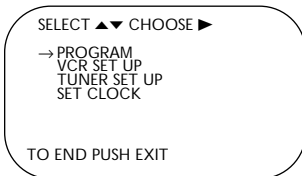

# 2

Press the PLAY/▲ button or the STOP/▼ button to select SET CLOCK, then press the F.FWD/► button.

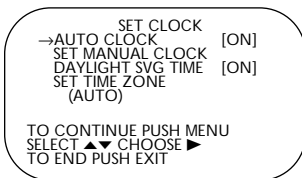

# 3

Press the PLAY/▲ button or the STOP/▼ button to select SET TIME ZONE, then press the F.FWD/► button.

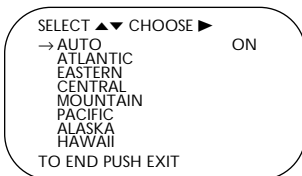

# 4

Press the PLAY/▲ button or the STOP/▼ button to select your time zone. ON will appear beside your choice.

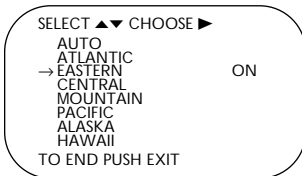

# 5

Press the STATUS/EXIT button.

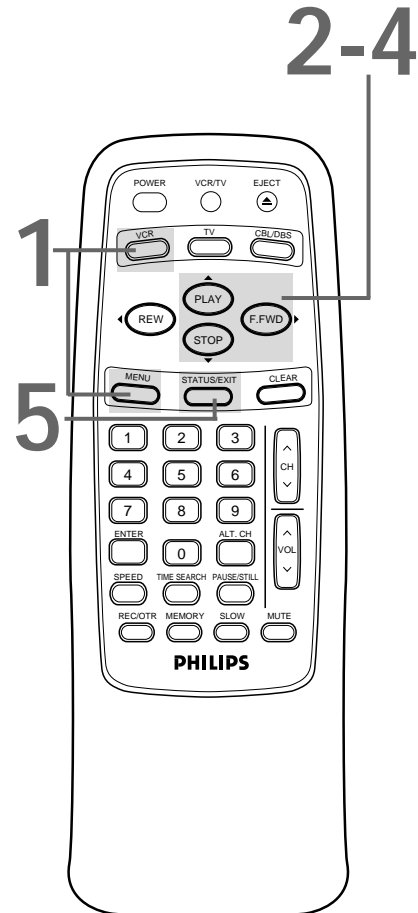

### Helpful Hints

- SET TIME ZONE will not appear in the menu if AUTO CLOCK is set to OFF.
- You may need to turn off the VCR to enable the VCR to set its clock for your time zone.

## Daylight-Savings Time 19

You may program the VCR so its clock will automatically move forward one hour in April and turn back one hour in October. Daylight-Savings Time is set to ON when you receive your VCR. Turn Daylight-Savings Time ON or OFF by following the steps below. Before you begin:

- Make sure the clock is set.

# 1

Press the **VCR** button.

# 2

Press the **MENU** button.

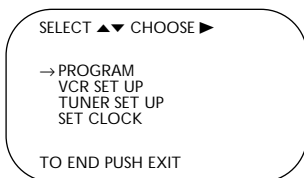

# 3

Press the **PLAY/▲** button or the **STOP/▼** button to select **SET CLOCK**, then press the **F.FWD/▶** button.

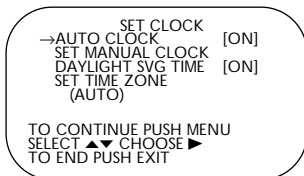

# 4

Press the **PLAY/▲** button or the **STOP/▼** button to select **DAYLIGHT SVG TIME**. Then, press the **F.FWD/▶** button so that **OFF** (or **ON**) appears beside **DAYLIGHT SVG TIME**.

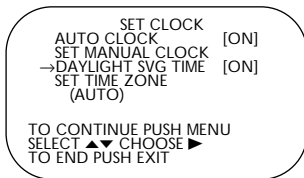

# 5

Press the **STATUS/EXIT** button.

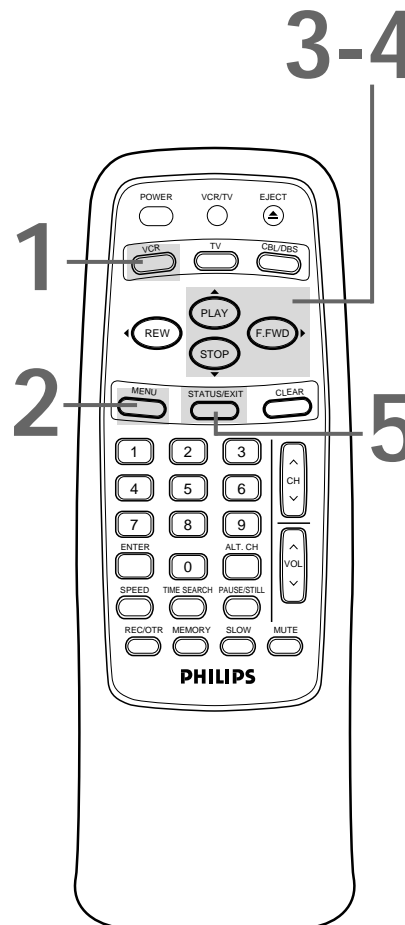

## 20 Language Selection

Follow the steps below to change the language of the on-screen displays and menus.

### 1

Press the VCR button.

### 2

Press the MENU button.

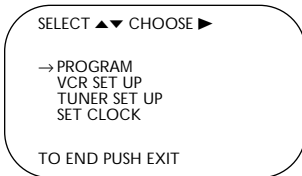

### 3

Press the PLAY/▲ button or the STOP/▼ button to select VCR SET UP, then press the F.FWD/► button.

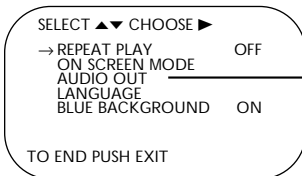

VRB612 only

### 4

Press the PLAY/▲ button or the STOP/▼ button to select LANGUAGE, then press the F.FWD/► button.

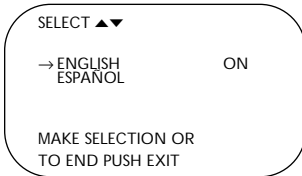

### 5

Press the PLAY/▲ button or the STOP/▼ button to select English or Spanish on-screen displays and menus.

### 6

Press the STATUS/EXIT button.

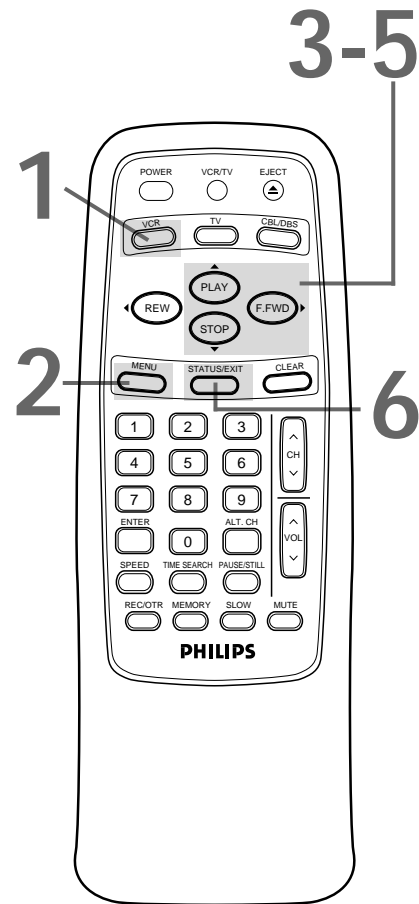

### Helpful Hint

- If you accidentally select Spanish and need English:
  1. Press the VCR button.
  2. Press the MENU button.
  3. Press the PLAY/▲ button or the STOP/▼ button to select PREPARE EL VCR, then press the F.FWD/► button.
  4. Press the PLAY/▲ button or the STOP/▼ button to select LENGUAJE, then press the F.FWD/► button.
  5. Press the PLAY/▲ button or the STOP/▼ button to select ENGLISH.
  6. Press the STATUS/EXIT button.

## Setting the Remote to Operate a TV 21

Your VCR remote control **may** operate your TV. If the remote control doesn't operate your TV now, follow the steps below.

# 1

Point the remote control at your TV and press the **TV** button. Then, press the **POWER** button. If your TV turns on or off, try the other TV buttons (see pages 23-24). If your TV doesn't turn on or off, or if the other buttons don't work, go to step 2.

# 2

Find the brand of your TV on the list below, and remember the two-digit number beside it.

TV CODES			
EMERSON	. . . . .14	PHILCO	. . . . .14
FISHER	. . . . .11	PHILIPS	. . . . .01
GE	. . . . .10	PHILIPS MAGNAVOX	.01, 02, 03
GOLDSTAR	. . . . .04	QUASAR	. . . . .07
HITACHI	. . . . .12	RCA	. . . . .10
JVC	. . . . .05	SAMSUNG	. . . . .17
MAGNAVOX	. . . . .01, 02, 03	SANYO	. . . . .11
MARANTZ	. . . . .13	SEARS	. . . . .08, 11
MITSUBISHI	. . . . .13	SHARP	. . . . .16
MONTGOMERY WARD	. . .14	SONY	. . . . .09
PANASONIC	. . . . .07	TOSHIBA	. . . . .08
PANASONIC-GAOO	. . . . .07	ZENITH	. . . . .06, 15

# 3

Press the **MUTE** button.

# 4

Within 30 seconds, press the **TV** button.

# 5

Within 30 seconds, press the **Number** buttons to enter the two-digit code for your TV brand. For example, if you have a Zenith TV, press Number buttons 0, 6.

# 6

**Repeat step 1.** If the remote control works your TV, you're finished. If the remote control still doesn't work your TV, repeat steps 3-5, using a different code for your brand (if available).

**There is no guarantee that the remote will work your TV.**

**1&6** Find your TV code.

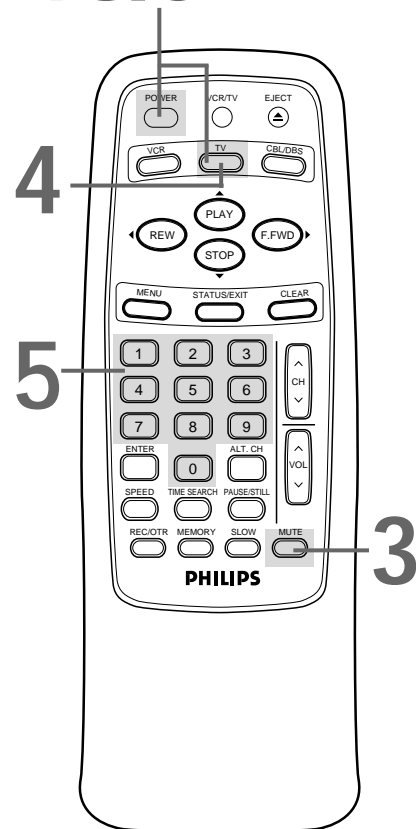

### Helpful Hints

- The remote control may only operate some features of your TV. For example, the remote control may turn on the TV power, but it may not change channels at the TV.
- If you can not change the channels at the TV using the Number buttons, press the ENTER button after you press the Number buttons. It may change channels at the TV.
- When you replace the batteries in the remote control, you must program the remote control again.
- Remember to point the remote control toward the TV during steps 1-6.

## 22 Setting the Remote to Operate a Cable Box/Direct Broadcast System

Your VCR remote control **may** operate your Cable Box or Direct Broadcast System (DBS). If the remote control doesn't operate your Cable Box or DBS now, follow the steps below.

# 1

Turn on the Cable Box/DBS. Then, point the remote control at your Cable Box/DBS and press the CBL/DBS button. Then, press the POWER button. If your Cable Box/DBS turns off, try the other Cable Box/DBS buttons (see pages 23-24). If your Cable Box/DBS doesn't turn off, or if the other buttons don't work, go to step 2.

# 2

Find the brand of your Cable Box or DBS on the lists below and remember the two-digit number beside it.

CABLE BOX CODES		
ARCHER.....01, 05, 06, 44	MAGNAVOX.....26	SAMSUNG.....05, 06,
CABLETENNA.....01, 44	MATSUSHITA	40, 42
CABLEVIEW.....04, 30,	.....16, 17, 97	SCIENTIFIC ATLANTA
42, 44, 52	MOVIETIME.....42, 44	.....08, 09
CENTURY.....44	NOVAVISION.....08, 09	SIGNAL.....26
CITIZEN.....04, 30,	NSC/NEC.....40	SL MARX.....06, 40, 42,
42, 44, 52	OAK.....11, 46	44, 52
CURTIS.....08, 09	OAK SIGMA.....11, 46	SPRUCER.....16, 17, 97
DIAMOND.....01, 44	PANASONIC.....16, 17, 97	STANDARD COMPONENTS
EAGLE.....26, 40, 62	PHILIPS.....07, 23, 50	.....42, 44
EASTERN/REGENCY	PIONEER.....05, 06	STARGATE.....04, 06, 30,
.....28	PULSAR.....04, 30, 42,	40, 42, 44, 52
GC BRAND.....04, 30,	44, 52	TELEVIEW.....06, 40, 42
42, 44, 52	QUEST.....05, 06	TOCOM.....01, 33, 34, 42
GEMINI/JASCO.....04	RCA.....16, 17, 97	UNIKA.....01, 44
GENERAL ELECTRIC	REALISTIC.....44	UNIVERSAL.....42, 44, 52
.....01, 57	RECOTON.....44	VIDEOWAY.....07, 23, 50
GENERAL INSTRUMENT	REGAL.....14, 15, 28, 41	VIEWSTAR.....26, 40, 62
.....01, 02, 03, 04, 34, 83	REMBRANDT	ZENITH.....07, 23, 50
HAMLIN.....14, 15, 28, 41	.....01, 42, 44	
JERROLD.....01, 02, 03,		
04, 34, 83		

DIRECT BROADCAST SYSTEM CODES		
MAGNAVOX.....94,95	RCA.....97	SONY.....98

# 3

Press the MUTE button.

# 4

Within 30 seconds, press the CBL/DBS button.

# 5

Within 30 seconds, press the Number buttons to enter the two-digit code for your Cable Box or DBS. For example, if you have a Zenith Cable Box, press Number buttons 0,7.

# 6

Repeat step 1. If the remote control works your Cable Box or DBS, you're finished. If the remote control still doesn't work your Cable Box or DBS, repeat steps 3-5, using a different code for your brand, if available.

# 1 & 6

# 2

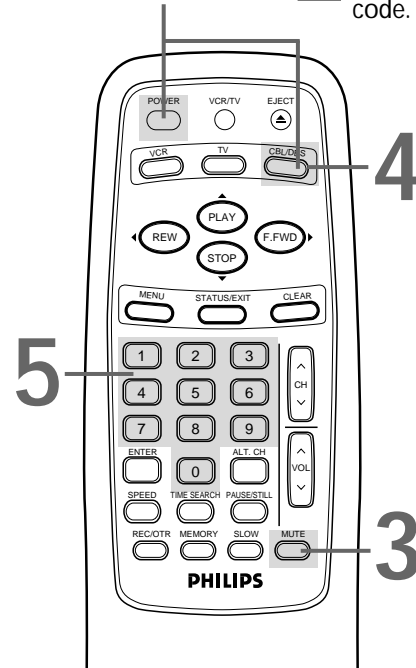
 Find your code.

**There is no guarantee that the remote will work your Cable Box or DBS.**

### Helpful Hints

- The remote control may only operate some features of your Cable Box/DBS. For example, the remote control may turn off the Cable Box/DBS power, but it may not change channels at the Cable Box/DBS.
- If you can not change the channels at the Cable Box by using the Number buttons, press the ENTER button after you press the Number buttons. It may change channels at the Cable Box.
- When you replace the batteries in the remote control, you will have to program the remote control again.
- Remember to point the remote control toward the Cable Box/DBS during steps 1-6.
- Some Cable Boxes can only be turned on at the Cable Box.

## Remote Control Buttons 23

**EJECT Button**  
Press to eject the tape.

**POWER Button**  
Press to turn on or off the VCR, TV, Cable Box, or Direct Broadcast System. (You must first press the VCR, TV, or CBL/DBS button.)

**VCR Button**  
Press to operate the VCR.

**PLAY/▲ Button**  
Press to play a tape; press to release Slow, Search, or Still mode and return to normal playback. *Details are on page 41.* Press to select an item in the VCR menu. Or, if you have a Magnavox, Philips, or Philips Magnavox TV, press when in TV mode to select an item in the TV menu.

**MENU Button**  
Press to access the VCR menu. Or, if you have a Magnavox, Philips, or Philips Magnavox TV, press the TV button, then press the MENU button to display the TV menu.

**Number Buttons**  
Press to select channels at the VCR, TV, Cable Box, or Direct Broadcast System; use to set up VCR features (such as the clock).

**Cable Users ●**  
At the VCR, enter channel numbers as a two-digit number for the quickest results. For example, to select channel 6, press 0,6. If you only press the Number 6 button, channel 6 will be selected after a brief delay. (There also may be a brief delay when you select channels 10, 11, and 12.) If you want to select channels 100 and above, enter channel numbers as a three-digit number. For example, to select channel 117, press 1, 1, 7.

**Antenna Users ●**  
Enter channel numbers as a two-digit number for the quickest results. You may only select channels 2-69. For example, to select channel 5, press 0,5. If you only press the Number 5 button, channel 5 will be selected after a brief delay.

**SPEED Button**  
Press to select the recording speed (SP or SLP). *Details are on pages 35 and 49.*

**REC(ord)/OTR Button**  
Press once to start a recording. *Details are on page 30.* Or, press repeatedly to start a One-Touch Recording. *Details are on page 32.*

**MEMORY Button**  
Press to memorize a tape position at which the real-time counter was set to 0:00:00. *Details are on page 39.*

**PAUSE/STILL Button**  
While recording, press to temporarily stop the recording (pause). Press a second time to resume normal recording. *Details are on page 30.* You can not pause a One-Touch Recording. During playback, press to freeze the picture (still). Press again to resume playback. *Details are on page 41.*

**SLOW Button**  
During tape playback, press to view the picture in slow motion. Press again to resume normal playback. *Details are on page 41.*

**MUTE Button**  
Press to eliminate the sound at your TV. Press again to restore the volume.

**VOL(ume) ▲/▼ Button**  
Press to adjust the volume of your TV.

### Helpful Hint

- Press the VCR button before pressing VCR feature buttons; press the TV button before pressing TV feature buttons; press the CBL/DBS button before pressing Cable Box/Direct Broadcast System feature buttons.

## 24 Remote Control Buttons (cont'd)

### VCR/TV Button

Use to select the signal that your TV receives.

### VCR Position ●

Use to watch a tape, to watch a program while recording it, or to watch a TV broadcast using the CH(annel) ▲/▼ or Number buttons to change channels at the VCR. If the VCR light appears on the display panel of the VCR, it is in VCR position.

### TV Position ●

Use to watch TV (changing channels at the TV) or to watch one program while recording another. *Details are on page 31.* If the VCR light doesn't appear on the display panel of the VCR, it is in TV position.

### REW(ind)/◀ Button

When tape playback is stopped, press to rewind the tape at high speed. During playback, press to rewind the tape while the picture stays on the screen. *Details are on page 41.* Or, if you have a Magnavox, Philips, or Philips Magnavox TV, use the REW(ind)/◀ button to adjust the controls in the TV menu.

### STOP/▼ Button

Press to stop the tape. Press to select an item in the VCR menu. Or, if you have a Magnavox, Philips, or Philips Magnavox TV, press when in TV mode to select an item in the TV menu.

### ENTER Button

Press after pressing the Number buttons to select a channel at the TV or the Cable Box. *Details are on pages 21-22.*

### TIME SEARCH Button

Press to fast forward or rewind the tape a specific length of time. *Details are on page 40.*

### ALT. CH (Alternate Channel) Button

Press while in TV position to return to the TV channel you were viewing immediately before switching to your current channel. This button does not have an effect on channels changed at the VCR.

### CH(annel) ▲/▼ Button

Press to change channels at the VCR, TV, Cable Box, or Direct Broadcast System.

### STATUS/EXIT Button

Press to access or remove the on-screen status display. *Details are on page 25.* Press to exit on-screen menus. Or, if you have a Magnavox, Philips, or Philips Magnavox TV, press the TV button, then press the STATUS/EXIT button to access or remove a TV status display or to remove the TV menu.

### CLEAR Button

Press to erase incorrect data when programming VCR functions. Also, press to reset the real-time counter. *Details are on page 39.*

### F.FWD(Fast Forward)/▶ Button

When playback is stopped, press to fast forward the tape at high speed. During playback, press to fast forward the tape while the picture stays on the screen. *Details are on page 41.* Or, if you have a Magnavox, Philips, or Philips Magnavox TV, use to adjust the controls in the TV

### CBL/DBS Button

Press to operate the Cable Box or Direct Broadcast System. *Details are on page 22.*

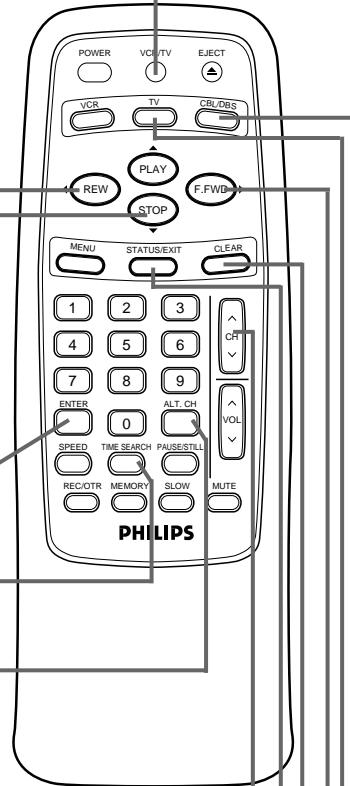

### TV Button

Press to operate the TV. *Details are on page 21.*

### Helpful Hint

- Buttons with a shaded description may also operate features of your TV, Cable Box, or Direct Broadcast System.



## On-Screen Status Displays 25

A status display will appear when you press the STATUS/EXIT button or certain function buttons. The contents of the status display will vary. To choose the status display mode, follow the steps below.

If you select **STATUS ON**, then select **COUNTER ONLY ON**:

- Whenever you press the STOP/▼ button or the PLAY/▲ button, the status display will appear for five seconds. After five seconds, only the counter will remain on the screen. You must press the STATUS/EXIT button to remove it. Portions of the status display also may appear when you press other function buttons.

If you select **STATUS ON**, then select **COUNTER ONLY OFF**:

- Whenever you press the STOP/▼ button or the PLAY/▲ button, the status display will appear for five seconds. Portions of the status display also may appear when you press other function buttons.

If you select **STATUS OFF**:

- The status display will not appear when you press function buttons. You must press the STATUS/EXIT button to see the status display.

# 1

Press the VCR button, then press the MENU button.

# 2

Press the PLAY/▲ button or the STOP/▼ button to select VCR SET UP, then press the F.FWD/▶ button.

# 3

Press the PLAY/▲ button or the STOP/▼ button to select ON SCREEN MODE, then press the F.FWD/▶ button.

# 4

Press the PLAY/▲ button or the STOP/▼ button to select STATUS, then press the F.FWD/▶ button so that OFF (or ON) appears beside STATUS.

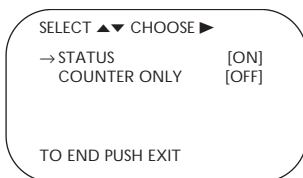

# 5

If you set STATUS to OFF, go to step 6. If you set STATUS to ON, press the PLAY/▲ button or the STOP/▼ button to select COUNTER ONLY, then press the F.FWD/▶ button so that OFF (or ON) appears beside it.

# 6

Press the STATUS/EXIT button.

### Status Display (example only)

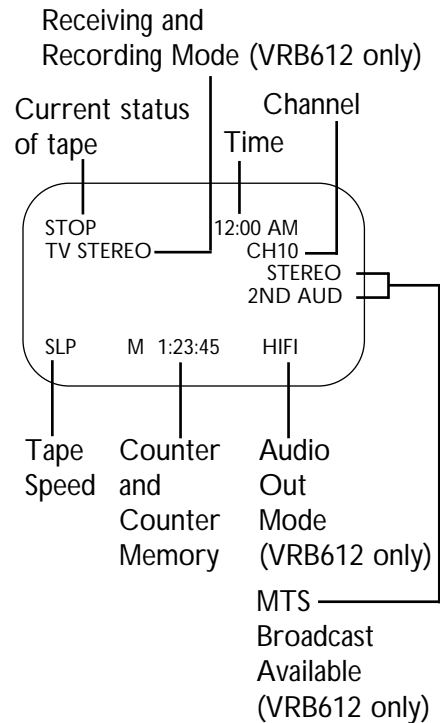

### Helpful Hint

- You may not access a status display when viewing a still picture, during slow motion playback, or during a search.
- A status display may not be available when you are watching TV if Blue Background is set to OFF. Details are on page 46.

## 26 VCR Display Panel

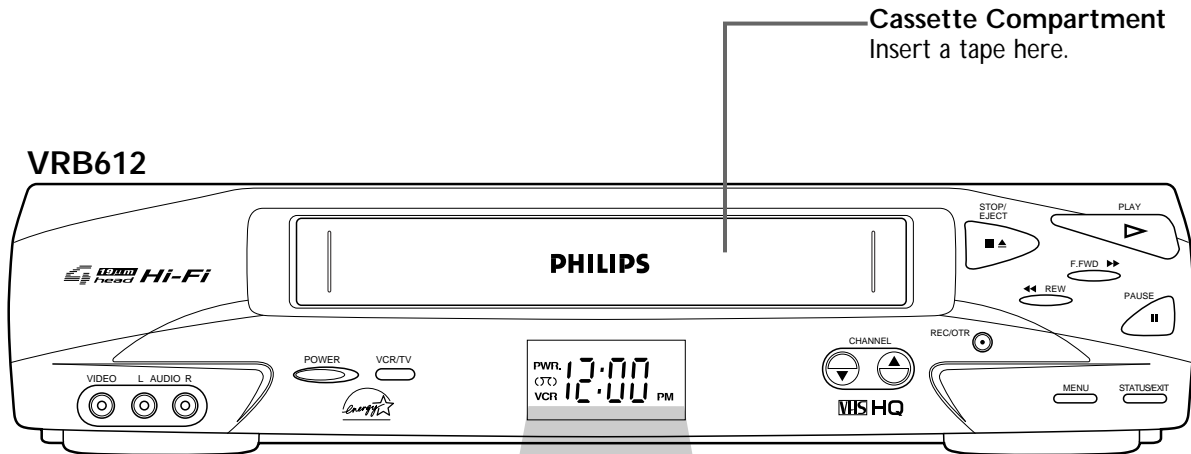

**Cassette Compartment**  
Insert a tape here.

VRB612

**PWR.(power) Light**  
This light appears when the power is on.

**Cassette-Inside Light**  
This light appears when there is a tape in the VCR.

**VCR Light**  
This light appears when the VCR is in VCR position. This light does not appear when the VCR is in TV position.

**REC(ord) Light**  
This light appears during a recording. It flashes when a recording is paused.

**Timer Light**  
This light glows when the VCR is turned off to set a timer recording or during a One-Touch Recording. It flashes if the power is off for a timer recording, but there is no tape in the VCR. It flashes when all timer recordings are finished.

**Clock Display**  
The current time appears here when the clock is set. If the clock is not set, -:-- will appear here. PM will appear on the display, but AM will not.



## Remote Sensor

Receives a signal from your remote control so you can operate your VCR from a distance.

## POWER Button

Press to turn the VCR power on and off.

## VIDEO In Jack

Connect a video cable coming from the video out jack of a camcorder, another VCR, or an audio-visual source (laser disc player, video disc player, etc.) here. *Details are on page 37.*

## VRB612

## AUDIO In Jacks

Connect audio cables coming from the audio out jacks of a camcorder, another VCR, or an audio source here. *Details are on page 37.* The VRB612 is shown here. The VRB412 has only one AUDIO In jack.

## VCR/TV Button

Press to select VCR or TV position.

### ● VCR Position

Use to watch a tape, to watch a program while recording it, or to watch a TV program (changing channels at the VCR). When the VCR light appears on the display panel, the VCR is in VCR position.

### ● TV Position

Use to watch TV (changing channels at the TV) or to watch one program while recording another. When the VCR light does not appear on the display panel, the VCR is in TV position.

## F.FWD (Fast Forward) Button

When playback is stopped, press to fast forward the tape at high speed. During tape playback, press to fast forward the tape while the picture stays on the screen. *Details are on page 41.* Press to select an item in the VCR menu or to change the setting of a menu item.

## REW(ind) Button

When playback is stopped, press to rewind the tape at high speed. During playback, press to rewind the tape while the picture stays on the screen. *Details are on page 41.* Press to return to a previous VCR menu.

## PLAY Button

Press to play a tape. Press to release Slow, Search, or Still mode and return to playback. *Details are on page 41.* Press to select an item in the VCR menu.

## STOP/EJECT Button

Press once to stop the tape. When playback is stopped, press to eject the tape. Press to select an item in the VCR menu.

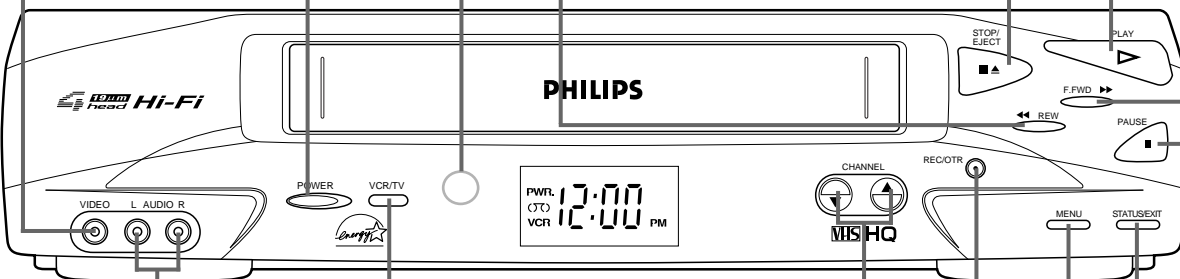

## CHANNEL (▼/▲) Buttons

Press to change channels at the VCR. Or, press to adjust the tracking of a tape during normal playback or slow motion playback. Also, press to remove vertical jitter in a Still picture.

## REC(ord)/OTR Button

Press once to start a recording. Press repeatedly to start a One-Touch Recording. *Details are on page 32.*

## MENU Button

Press to access the VCR menu.

## STATUS/EXIT Button

Press to access or remove the on-screen status display. *Details are on page 25.* Press to exit on-screen menus.

## PAUSE Button

While recording, press to pause the recording. Press again to resume recording. *Details are on page 30.* You can not pause a One-Touch Recording. During tape playback, press to freeze the picture. Press again to resume playback. *Details are on page 41.*

## 28 Rear Panel

---

### ANT(enna) IN Jack

Connect your antenna or cable here. Details are on pages six-10.

### AUDIO IN Jack(s)

Connect audio cables coming from the AUDIO OUT Jacks of a camcorder, another VCR, or an audio source here. Details are on page 37.

The VRB612 is shown here. The VRB412 has only one AUDIO IN jack.

### AUDIO OUT Jack(s)

Connect audio cables going to the AUDIO IN Jacks of a camcorder, another VCR, or an audio system here. Details are on pages 37 and 43.

The VRB612 is shown here. The VRB412 has only one AUDIO OUT jack.

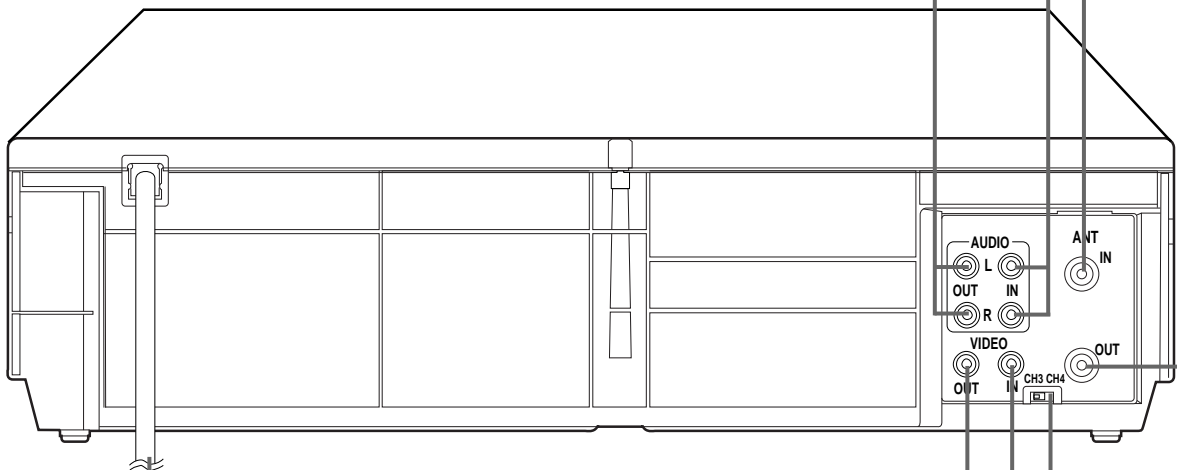

### VIDEO OUT Jack

Connect a video cable going to the VIDEO IN Jack of a camcorder, another VCR, or an audio-visual system (monitor, laser disc player, video disc player, etc.) here. Details are on pages 37 and 43.

### VIDEO IN Jack

Connect a video cable coming from the VIDEO OUT Jack of a camcorder, another VCR, or an audio-visual source (laser disc player, video disc player, etc.) here. Details are on page 37.

### CH3/CH4 Switch

Set to channel 3 or 4 to use your TV with your VCR. Details are on pages six-nine.

### AC Power Cord

Connect to a standard AC outlet to supply power to the VCR.

### OUT Jack

Use the supplied RF coaxial cable to connect this jack to the ANTENNA IN Jack on your TV, Cable Box, or Direct Broadcast System. Details are on pages six-nine.

## Playing 29

Read and follow the steps below to play a tape.

# 1

Turn on the TV and set it to channel 3 or 4, whichever channel the CH3/CH4 switch on the back of the VCR is set to.

# 2

Insert a tape in the VCR. The PWR., VCR, and Cassette-Inside lights will appear on the display panel. If the tape's record tab has been removed, playback will start automatically.

# 3

If playback does not start automatically, press the VCR button, then press the PLAY/▲ button.

# 4

Press the STOP/▼ button to stop playback.

# 5

Press the REW(ind)/◀ button to rewind the tape.

# 6

Press the EJECT button to remove the tape.

1 Turn on the TV.

2 Insert a tape in the VCR.

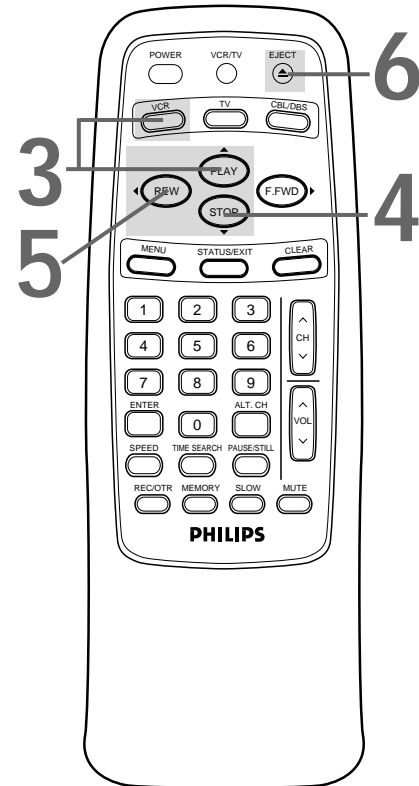

### S-VHS Quasi Play Back (SQPB)

This unit has a SQPB function that allows you to view a tape recorded in S-VHS format. A tape recorded in S-VHS format will play the same as a tape recorded in normal format. This unit detects whether the tape is recorded in S-VHS format or in normal format.

### Helpful Hints

- If the tape you want to play is already in the VCR, make sure the VCR power is on and the VCR is in VCR position. (The VCR light will appear on the display panel. If it does not, press the VCR/TV button once.) Press the VCR button, then press the PLAY/▲ button.
- Other playback options and features are on pages 38-45.
- When you play a tape recorded in S-VHS format on this unit, you can not get the high resolution that would be available on an S-VHS VCR. Noise lines (black and white streaks) may appear on the picture.
- If REPEAT PLAY is set to ON, playback will begin automatically, even when the record tab is intact.

## 30 Recording

Read and follow the steps below to record a television program.

**1**

Turn on the TV and set it to channel 3 or 4, whichever channel the CH3/CH4 switch on the back of the VCR is set to.

**2**

Insert a tape with its record tab intact in the VCR.

**3**

Press the VCR button.

**4**

If the VCR light appears on the display panel, go to step 5. If the VCR light does not appear, press the VCR/TV button once.

**5**

Press the SPEED button until the desired tape speed appears briefly on the screen. (Details about tape speed are on page 35.)

**6**

Use the CH(annel) ▲/▼ button or the Number buttons to select the channel to be recorded.

**7**

Press the REC(ord)/OTR button once to start recording. The REC(ord) light will appear.

**8**

To pause the recording, press the PAUSE/STILL button once. The REC(ord) light will flash. To resume recording, press the REC(ord)/OTR button or press the PAUSE/STILL button again. The REC(ord) light will come on again.

**9**

To stop recording, press the STOP/▼ button.

**1** Turn on the TV.

**2** Insert a tape in the VCR.

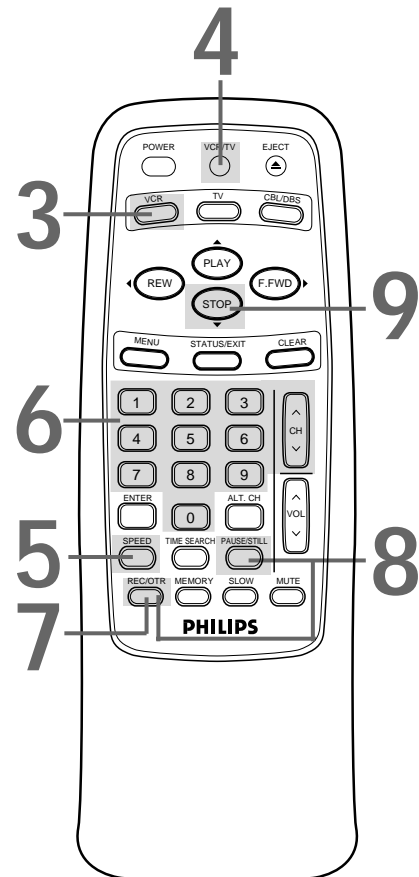

### Helpful Hints

- If you press the REC(ord)/OTR button when there is not a tape in the VCR, NO CASSETTE will flash on the screen.
- If you press the REC(ord)/OTR button while a tape without a record tab is in the VCR, the VCR will eject the tape and PROTECTED CASSETTE CANNOT RECORD will flash on the screen.
- Other recording options are on pages 31-37.
- You can change the tape speed during a recording, but some distortion will appear on the tape.
- The VCR will record in a preset volume.

## Recording One Channel/Watching Another 31

1

Press the VCR button.

2

Press the REC(ord)/OTR button to start a recording of the current channel. (See page 30.)

3

Press the VCR/TV button to put the VCR in TV position. The VCR light will disappear from the VCR's display panel.

4

Press the TV button, then press the CH(annel) ▲/▼ or Number buttons to select the channel you want to watch at the TV. (If the VCR remote control doesn't operate your TV, use the TV remote control to select the channel.)

5

To return to the channel being recorded, press the TV button, then use the Number buttons to select channel 03 or 04 at the TV (whichever channel the CH3/CH4 switch on the back of the VCR is set to). (If the VCR remote control doesn't operate your TV, use the TV remote control to select channel 03 or 04.)

6

Press the VCR button.

7

Press the VCR/TV button to put the VCR in VCR position. The VCR light will appear on the display panel. The channel being recorded will appear on the screen.

8

Press the STOP/▼ button to stop the recording.

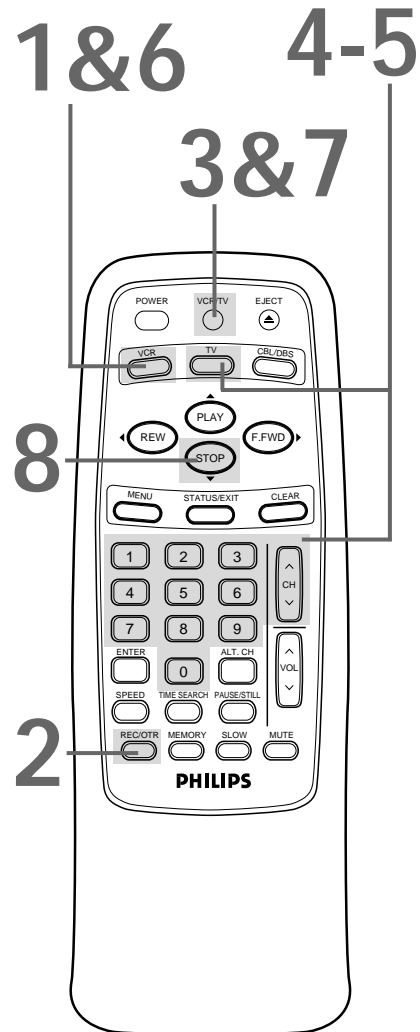

### Helpful Hints

- If your VCR remote control does not operate your TV, see page 21 for details.
- If you use a Cable Box or Direct Broadcast System hookup, you may not be able to watch one channel while recording another. See pages eight-nine for details.

## 32 One-Touch Recording

The One-Touch Recording (OTR) feature allows you to set an immediate timed recording 30 minutes to eight hours long. Before you begin:

- Set up the channels at the VCR.
- Select a recording speed (SP, SLP) with the SPEED button.
- Put a tape in the VCR. Make sure the tape's record tab is intact and the tape is long enough to record the program(s).
- Place the VCR in VCR position. (The VCR light will appear on the display panel. If it does not, press the VCR/TV button once.)

# 1

Press the VCR button, then press the CH(annel) ▲/▼ button or the Number buttons to select the channel you want to record.

# 2

Press the REC(ord)/OTR button repeatedly until the desired recording length (30 minutes to eight hours) appears on the screen. Recording will begin immediately. The REC(ord) light and the Timer light will appear on the display panel.

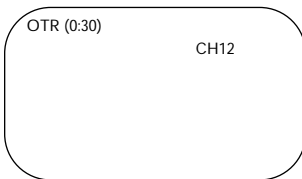

# 3

To stop an OTR before recording is finished, press the STOP/▼ button or the POWER button.

To cancel the OTR but continue recording, press the REC(ord)/OTR button repeatedly until REC appears in the upper left corner of the TV screen. (STATUS must be set to ON. See page 25 for details.) The REC(ord) light will remain on the display panel of the VCR, but the Timer light will disappear.

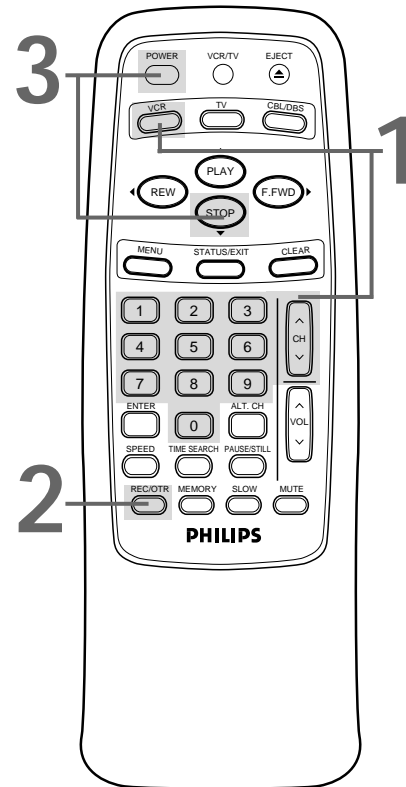

### Helpful Hints

- To check the time remaining for an OTR after the OTR has been set, press the STATUS/EXIT button.
- To change the recording length while an OTR is in progress, press the REC(ord)/OTR button until the desired length appears on the screen.
- If you begin an OTR when another recording is paused, the OTR will begin.
- You can not pause an OTR.
- If the preset time for a timer recording comes up during an OTR, the OTR has priority. A message will remind you when the timer recording was scheduled to begin. You may let the OTR continue; the timer recording will not take place. Or, stop the OTR and turn off the VCR immediately. The timer recording will take place if you turn off the VCR before the timer recording's scheduled start time.



## Timer Recording 33

Follow the steps below to program your VCR to record TV programs while you're away from home. The VCR will turn itself on, record, and turn itself off automatically. Before you begin:

- Set up the channels at the VCR.
- Set the clock.
- Put a tape in the VCR. Make sure the tape's record tab is intact and the tape is long enough to record the program(s).
- Put the VCR in VCR position. The VCR light will appear on the display panel. If it does not, press the VCR/TV button once.

Do each step within 60 seconds of the previous step.

# 1

Press the **VCR** button, then press the **MENU** button.

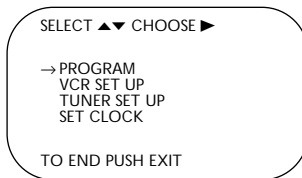

# 2

Press the **PLAY/▲** button or the **STOP/▼** button to select **PROGRAM**, then press the **F.FWD/▶** button.

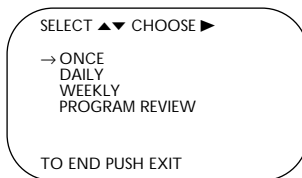

# 3

Press the **PLAY/▲** button or the **STOP/▼** button to select a **ONCE**, **DAILY**, or **WEEKLY** recording. Then, press the **F.FWD/▶** button.

- **ONCE:** The VCR will record a TV program on any day you choose, up to 12 months away.
- **DAILY:** The VCR will record the same channel every day from Monday to Friday – starting at the same time and recording for the same length of time.
- **WEEKLY:** The VCR will record the same channel on the same day, at the same time, and for the same length of time every week.

**Daily  
Recording  
(example)**

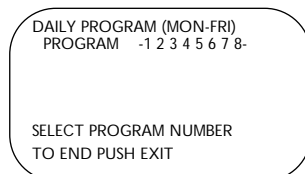

Instructions continue on page 34.

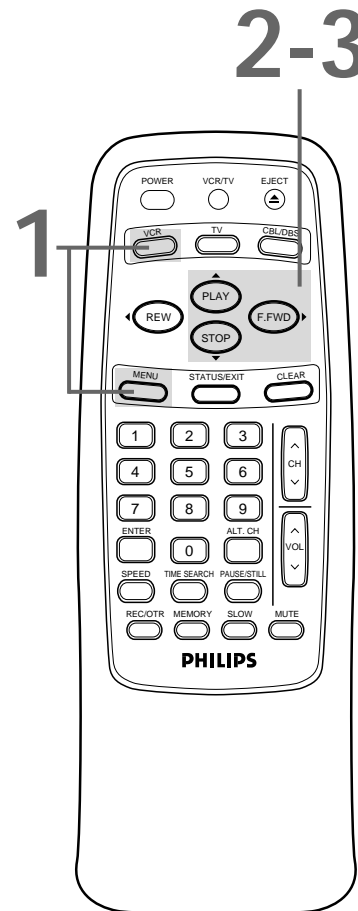

### Helpful Hint

- If you need to make a correction while programming a timer recording, press the **CLEAR** button until the cursor is flashing on the item you want to change. Then enter the correct information.

## 34 Timer Recording (cont'd)

### 4

Use the Number buttons (1 - 8) to select a slot in which to store the timer recording. There are eight slots. Numbers for open slots will flash on the screen.

*NOTE: If you enter a number for a slot that has already been used to store a timer recording, PREVIOUSLY SET PROGRAM will appear on the screen briefly. Information about the program in that slot will appear on the screen. If this happens, press the STATUS/EXIT button, then select another number.*

### 5

Use the Number buttons to enter the channel you want to record.

- Cable Users, enter channel numbers as a two-digit number for the quickest results. For example, to select channel 6, press 0,6. If you only press the Number 6 button, channel 6 will be selected after a brief delay. There also may be a brief delay when you select channels 10, 11, and 12. If you want to select channels 100 and above, enter channel numbers as a three-digit number. For example, to select channel 117, press 1, 1, 7. Antenna Users, enter channel numbers as a two-digit number for the quickest results. For example, to select channel 5, press 0,5. If you only press the Number 5 button, channel 5 will be selected after a brief delay.
- If you are recording from line input, press 0,0 to select AV REAR.
- If you are using a Cable Box/DBS, select the Cable Box/DBS output channel (03 or 04). Set the Cable Box/DBS to the channel you want to record. Leave the Cable Box/DBS on for the timer recording. See page eight for details.

### 6

Press two Number buttons for the hour you want the recording to begin. Press two Number buttons for the minute you want the recording to begin. Press 1 for AM or 2 for PM. For example, for 9:30 PM, press 09, 30, 2.

```
ONE TIME PROGRAM
PROGRAM 1
CHANNEL 10
TIME ON  ---:--
```

TO CORRECT PUSH CLEAR  
TO END PUSH EXIT

### 7

Follow the instructions in step 6 to enter the recording's stop time. (AM or PM will be set automatically.)

```
ONE TIME PROGRAM
PROGRAM 1
CHANNEL 10
TIME ON  09:30 PM
TIME OFF  ---:--
```

TO CORRECT PUSH CLEAR  
TO END PUSH EXIT

### 4-7

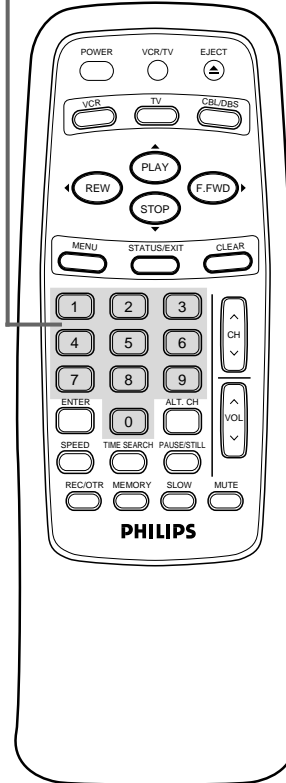

### Helpful Hints

- Entries that do not match the VCR's clock or calendar will cause a question mark to appear on the screen.
- If you are recording from line input, connect the audio and video cables to the AUDIO IN and VIDEO IN jacks on the back of the VCR. (Please see illustration on page 37.)

# 8

Press the **Number 1** button to record in **SP** speed or the **Number 2** button to record in **SLP** speed. (See the chart below.) You cannot use the **SPEED** button at this time.

```

ONE TIME PROGRAM
PROGRAM      1
CHANNEL     10
TIME ON     09:30 PM
TIME OFF    11:00 PM
REC SPEED   SLP
SP=1  SLP=2
    
```

TO CORRECT PUSH CLEAR  
TO END PUSH EXIT

# 9

Press two **Number** buttons for the month and two **Number** buttons for the day you want to record the program. For example, for July 10, 2000, press 07, 10. The day of the week and the year will appear automatically (you cannot program the VCR to record more than one year in advance).

```

ONE TIME PROGRAM
PROGRAM      1
CHANNEL     10
TIME ON     09:30 PM
TIME OFF    11:00 PM
REC SPEED   SLP
START DATE  07/10/00
            MON.
    
```

TO CORRECT PUSH CLEAR  
TO END PUSH EXIT

# 10

Press the **STATUS/EXIT** button. PROGRAM WAS COMPLETED / PLEASE TURN OFF VCR FOR TIMER RECORDING will appear on the screen briefly. (If PROGRAM NOT COMPLETED appears, try again from step 1.)

# 11

Press the **POWER** button to turn off the **VCR** power. The Timer light will appear on the display panel. If the timer recording will take place several hours or days from now, you may use the VCR until time for the recording. Turn off the VCR a few minutes before the recording starts. If you forget to turn off the VCR, PLEASE TURN OFF VCR FOR TIMER RECORDING flashes on your TV screen two minutes before a timer recording starts. Press the **CLEAR** button to remove the message.

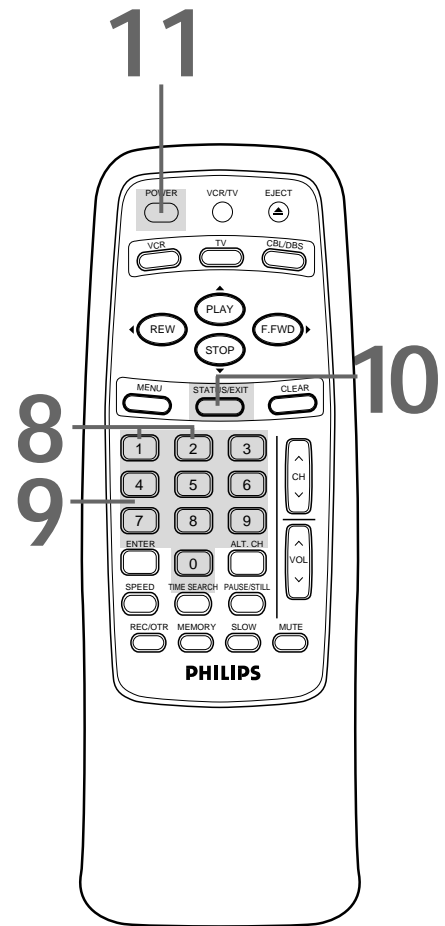

**Turn off the VCR for the recording. Insert a tape in the VCR. Leave the Cable Box/DBS on (if applicable).**

Tape Speed	Cassette type / Playback Time		
	T160	T120	T60
SP (standard play)	2 hrs. 40 mins.	2 hrs.	1 hr.
LP (long play) (playback only)	5 hrs. 20 mins.	4 hrs.	2 hrs.
SLP (super long play)	8 hrs.	6 hrs.	3 hrs.

**Tape Speeds**

This chart shows the recording/playback time for three types of video cassettes (T160, T120, and T60). There are three playback speeds: SP, LP, and SLP. When recording, you can change the tape speed (SP or SLP) using the **SPEED** button. You cannot record in LP speed.

## 36 Timer Recording (cont'd)

### Checking or Cancelling Timer Recordings

1

With the VCR on and in VCR position (the VCR light will appear on the display panel), press the **VCR** button, then press the **MENU** button.

2

Press the **PLAY/▲** button or the **STOP/▼** button to select **PROGRAM**, then press the **F.FWD/▶** button.

3

Press the **PLAY/▲** button or the **STOP/▼** button to select **PROGRAM REVIEW**, then press the **F.FWD/▶** button.

The timer recording information for the program in the lowest numbered slot will appear on the screen. If no timer recordings are set, nothing will happen when you press the **F.FWD/▶** button.

4

Press the **F.FWD/▶** button repeatedly to review all programmed timer recordings. If you don't press the **F.FWD/▶** button within 10 seconds, the VCR will automatically display information about the next programmed timer recording. This will continue until all timer recordings have been displayed. Then the menu will disappear.

5

To cancel the timer recording displayed, press the **CLEAR** button. Either the display will disappear or information about other timer recordings will appear. If you do not press any other buttons, the display will disappear after all timer recordings have been displayed.

6

Repeat steps 1 - 4 to make sure you have cleared the correct timer recording.

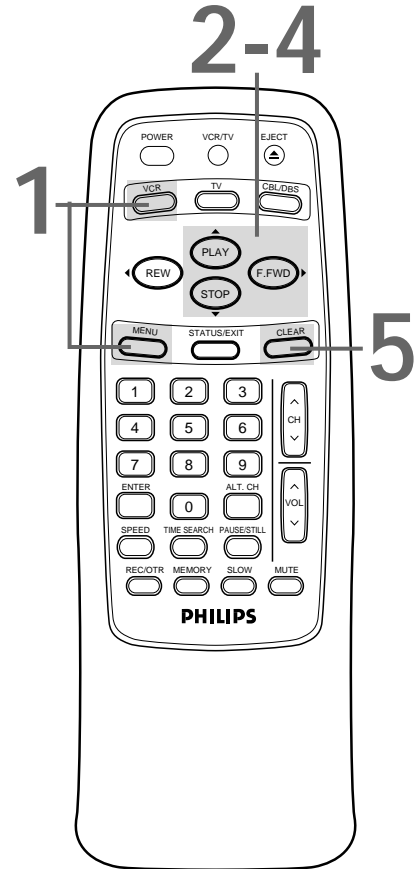

### Helpful Hints

- *CLASH* may flash on the screen when you finish setting a timer recording. This means that the timer recording you just programmed and another timer recording overlap. The current timer recording will not take place. You may choose to cancel the overlapping timer recording.
- To stop a started timer recording, press the **STOP/EJECT** button on the VCR.
- If the power fails for more than one minute, programmed timer recordings will be lost. If this occurs, repeat the steps on pages 11 and 15 before resetting the timer recordings.
- If the preset time for a timer recording comes up during an OTR, the OTR has priority. A message will remind you when the timer recording was scheduled to begin. You may let the OTR continue; the timer recording will not take place. Or, stop the OTR and turn off the VCR immediately. The timer recording will take place if you turn off the VCR before the timer recording's scheduled start time.

See page 47 for more hints.

## Rerecording (Tape Duplication) 37

The instructions on this page show you how to copy tapes. The illustration uses two VRB612 VCRs. Different VCRs may operate differently. To duplicate a tape, make the connections shown, then follow steps 1-7.

### 1. Audio cables from AUDIO OUT Jacks of VCR 1 to AUDIO IN Jacks of VCR 2

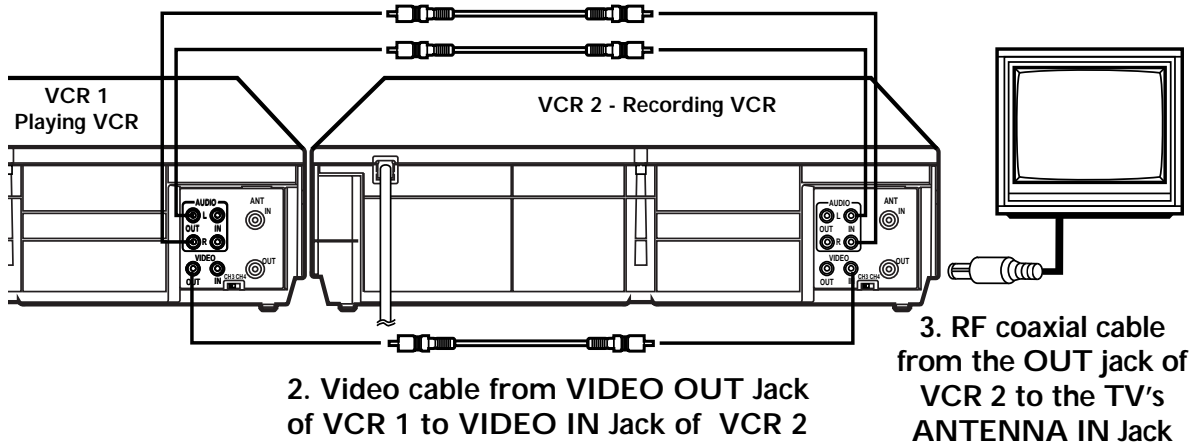

- Audio and Video cables are not supplied.

# 1

Make the connections shown above.

# 2

VCR 1 will play your tape. Put a prerecorded tape in VCR 1.

# 3

VCR 2 will record your tape. Insert a blank tape in VCR 2. The VCR must be in VCR position. (The VCR light will appear on the display panel. If it does not, press the VCR/TV button once.)

# 4

Turn on the TV and set it to channel 03 or 04, whichever channel the CH3/CH4 switch on VCR 2 is set to.

# 5

Point the remote control at VCR 2. Press the VCR button, then press Number buttons 0, 0, 1 or 0, 0, 2. (See Helpful Hints at right.)

# 6

Press the SPEED button to select SP or SLP at VCR 2.

# 7

Press the PLAY button on VCR 1 and the REC(ord)/OTR button on VCR 2 at the same time.

To stop recording, press the STOP/EJECT button on VCR 1, then press the STOP/EJECT button on VCR 2.

### Helpful Hints

- If you use the AUDIO and VIDEO IN Jacks on the back of VCR 2, press Number buttons 0, 0, 1. AV REAR will appear on the screen. (Blue Background should be set to ON. Details are on page 46.)
- If you use the AUDIO and VIDEO In Jacks on the front of VCR 2, press Number buttons 0, 0, 2. AV FRONT will appear on the screen. (Blue Background should be set to ON. Details are on page 46.)
- Unauthorized recording of copyrighted television programs, video tapes, or other materials may infringe on the rights of copyright owners and violate copyright laws.
- If a program has copyright protection, it may not record clearly.
- These instructions show you how to copy tapes using two VCRs like yours. Different VCRs may operate differently.
- The VCR in the figure above is the VRB612. If you have the VRB412, use a single-plug audio cable to connect the AUDIO OUT jack on VCR 1 to the AUDIO IN jack on VCR 2.

## 38 Repeat Play

Follow the steps below to make the VCR play a tape over and over.

# 1

Press the **VCR** button.

# 2

Press the **MENU** button.

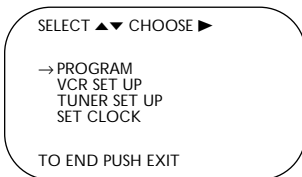

# 3

Press the **PLAY/▲** button or the **STOP/▼** button to select **VCR SET UP**, then press the **F.FWD/▶** button.

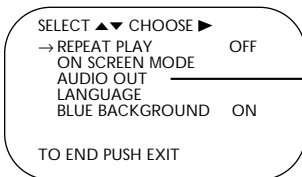

VRB612 only

# 4

Press the **PLAY/▲** button or the **STOP/▼** button to select **REPEAT PLAY**.

# 5

Press the **F.FWD/▶** button so that **ON** appears beside **REPEAT PLAY**.

# 6

Press the **STATUS/EXIT** button. Now, when a tape has finished playing, the VCR will rewind it and start playback again.

# 3-5

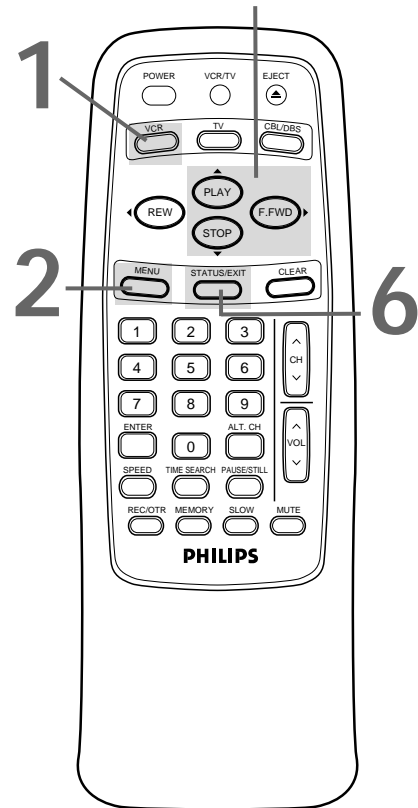

### Helpful Hints

- To cancel Repeat Play, follow steps 1-4 above. At step 5, press the **F.FWD/▶** button so that **OFF** appears beside **REPEAT PLAY**. Press the **STATUS/EXIT** button.
- The real-time counter memory does not function during Repeat Play.

## Real-Time Counter Memory 39

Follow the steps below to reset the real-time counter to zero at a tape location you want to refer to later.

# 1

Press the **VCR** button.

# 2

Play, fast forward, or rewind a tape to the location that you would like to refer to later. Press the **STOP/▼** button to stop the tape.

# 3

Press the **STATUS/EXIT** button to see the status display.

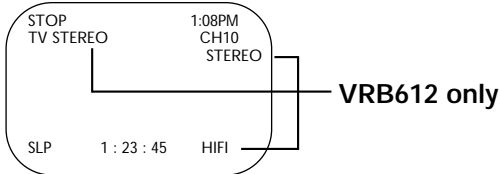

# 4

While the status display is on the screen, press the **CLEAR** button to reset the real-time counter to zero.

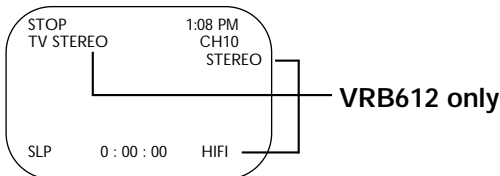

# 5

While the real-time counter is on the screen, press the **MEMORY** button so that **M** appears beside the counter.

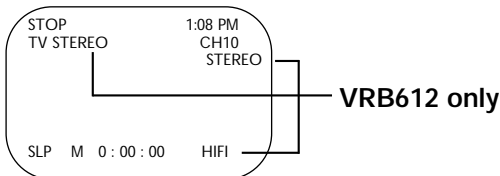

# 6

To go to a tape location where the real-time counter was reset to zero, press the **REW(ind)/◀** button or the **F.FWD/▶** button when playback is stopped.

When the tape reaches the point at which the counter was set to zero, the tape will stop.

Press the **PLAY/▲** button to watch the tape.

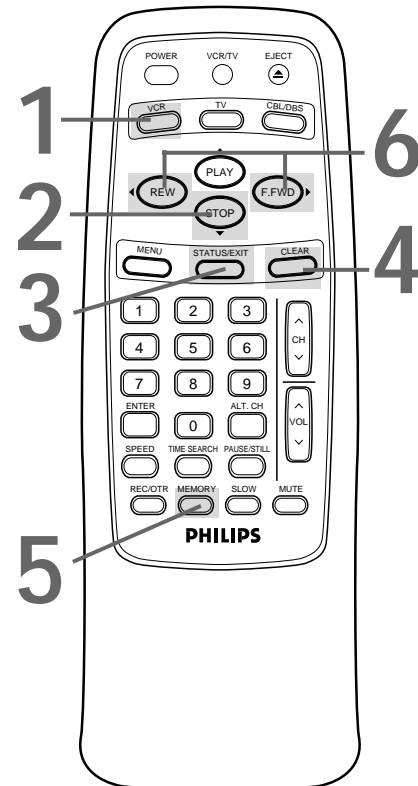

### Helpful Hints

- The **MEMORY** button does not function if **REPEAT PLAY** is set to **ON**. Details are on page 38.
- To erase a real-time counter memory, press the **MEMORY** button until the **M** disappears from the screen.
- You may only set the real-time counter to zero at one location at a time. If you set the real-time counter to zero at a second location, the previous real-time counter to zero setting will be erased.

## 40 Time Search

Follow the steps below to program the VCR to search forward or backward on a tape a specific length of time. There must be a tape in the VCR.

# 1

Press the VCR button.

# 2

Press the TIME SEARCH button.

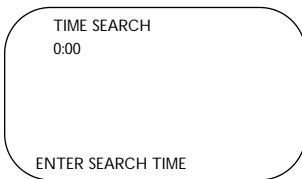

# 3

Within 10 seconds, use the Number buttons to enter the desired length of time you want to skip forward or backward. For example, for 1 hour, 25 minutes, press Number buttons 1, 2, 5. Or, for five minutes, press Number buttons 0, 0, 5.

# 4

Within 10 seconds, press the F.FWD/▶ button or the REW(ind)/◀ button. The VCR will skip over the specified length of time, then begin playback.

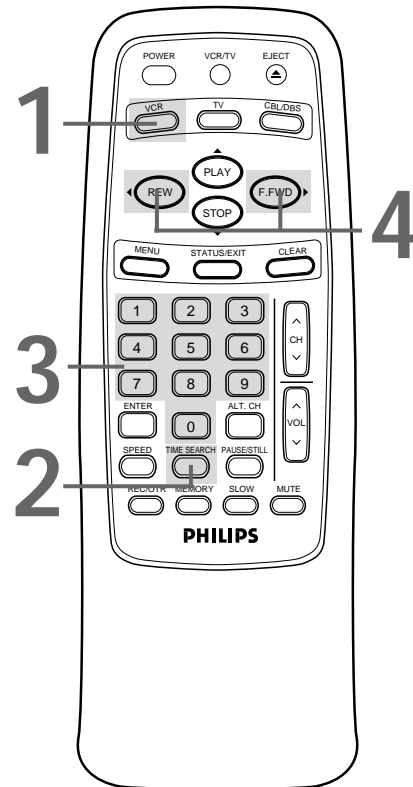

### Helpful Hints

- If you want to search for more than 59 minutes, you must enter the length of time in hours and minutes. For example, to search forward 70 minutes, press 1,1,0 at step 3.
- You can not do a Time Search while recording.
- To remove the Time Search display, press the TIME SEARCH button again.
- To cancel a Time Search that is in progress, press the STOP/▼ button.



### Forward and Reverse Searching (SP/LP/SLP)

1

During tape playback, press and release the F.FWD/▶ button or the REW(ind)/◀ button. A fast forward or reverse picture search will begin.

2

To return to playback, press the PLAY/▲ button.

### Super High Speed Searching (LP/SLP)

1

During tape playback, press the F.FWD/▶ button or the REW(ind)/◀ button, then press again. The VCR will now search in super high speed.

2

To return to normal playback, press the PLAY/▲ button.

### Viewing a Still Picture

1

During tape playback, press the PAUSE/STILL button. A still picture will appear on the screen.

2

To release the still picture and return to playback, press the PLAY/▲ button or press the PAUSE/STILL button again.

### Viewing a Slow Motion Picture

1

During tape playback, press the SLOW button. The tape will play in slow motion.

2

To release Slow mode and return to normal playback, press the PLAY/▲ button or press the SLOW button again.

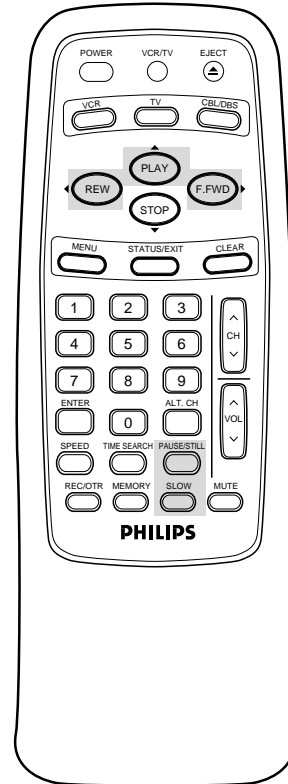

#### Helpful Hints

- Slow and Still modes will automatically switch to Stop mode after five minutes to protect the VCR and the tape from damage.
- SP/LP/SLP means this feature will work with tapes recorded in Standard Play, Long Play, or Super Long Play.
- LP/SLP means this feature will work with tapes recorded in Long Play or Super Long Play. For details about tape speed, see pages 35 and 49.

## 42 Automatic Operation Features

---

The following playback features will always operate.

### Automatic Playback

When you put a tape in the VCR, the power will come on automatically. If the tape's record tab is missing, playback will begin.

If a timer recording is set, the power will not come on automatically when you insert a tape with the record tab intact.

If a timer recording is set and the VCR power is off, the VCR will eject the tape if the record tab is missing.

### Automatic Rewind, Eject, Off

When a tape is played, fast forwarded, or recorded to its end, the VCR will rewind the tape, stop, eject the tape, then turn itself off.

If the real-time counter memory is set, the VCR will only rewind the tape to the point at which the counter is set to zero, then stop. The VCR will not eject the tape automatically or shut itself off.

### Tape Eject

A tape can be ejected with the VCR power on or off (but the VCR must be plugged in). If a timer recording is set, a tape can only be ejected with the power on. Make sure you insert a tape and turn off the VCR power for the timer recording.

### Automatic Tracking Adjustment

The VCR adjusts tracking automatically to give you the best possible picture quality. With some recordings, however, you may get a better picture using the manual tracking controls (see below).

### Manual Tracking

To manually adjust the tracking during playback and slow motion playback, press the CHANNEL ▲/▼ buttons **on the VCR**. (The CH(annel) ▲/▼ button on the remote control will not adjust tracking.)

Tracking will return to Automatic Tracking Adjustment when you press the STOP/▼ button or insert a tape.

You cannot manually adjust the tracking of a Still picture.

However, you may press the CHANNEL ▲/▼ buttons on the VCR to remove vertical jitter in a Still picture.

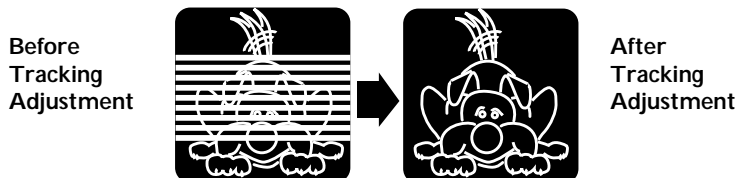

## Multi-Channel Television Sound System (VRB612 only) 43

Your VCR can play recordings broadcast in Hi-Fi (high fidelity) stereo, which produces a crisp, clear sound from two sources. Your VCR also can play tapes recorded in a second audio (usually, that means your program is recorded in a second language). Of course, your VCR will play tapes recorded in monaural (single-source) sound as well.

Your VCR also will record in Hi-Fi stereo or in second audio, so when you play back that tape on the VCR, it will be in stereo or second audio. If you play back the tape on a VCR that can't play back tapes in stereo or second audio, the VCR will automatically play the tape in monaural sound.

Read the directions on this page to familiarize yourself with your VCR's stereo and second audio setups. Then follow the directions on page 44 to record in stereo or second audio and the directions on page 45 to play back tapes recorded in Hi-Fi stereo.

### Understanding On-Screen Displays

When you receive a signal from a channel you're watching, portions of the on-screen display shown below will appear when you press the STATUS/EXIT button on the remote control.

The indication 2ND AUD or TV STEREO that appears on this side of the status display tells you if your VCR is programmed to receive a second audio or stereo broadcast (it cannot be programmed to receive both at the same time).

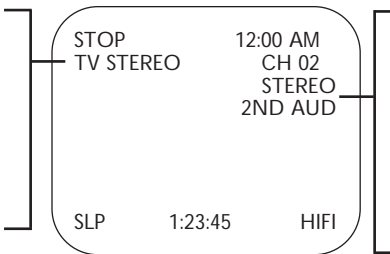

The indication 2ND AUD or STEREO that appears on this side of the status display tells you if the program you're watching is available in second audio or stereo. This indication is not available during tape playback.

Specifically...

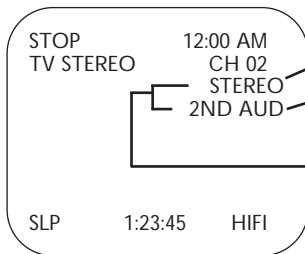

When a program broadcast in stereo is available, STEREO appears here.

When a program broadcast in second audio is available, 2ND AUD appears here.

When a program is available both in stereo and second audio, both STEREO and 2ND AUD appear here. Even though a program is available in stereo or second audio, you still must program the VCR to receive or record the program. Follow the directions on page 44.

**NOTE:** Although a program may be broadcast in both stereo and second audio, you cannot record in both stereo and second audio at the same time.

To record and play back programs broadcast in stereo, even if you have a Single Speaker TV, just use one of the connections shown, then follow the steps on pages 44-45.

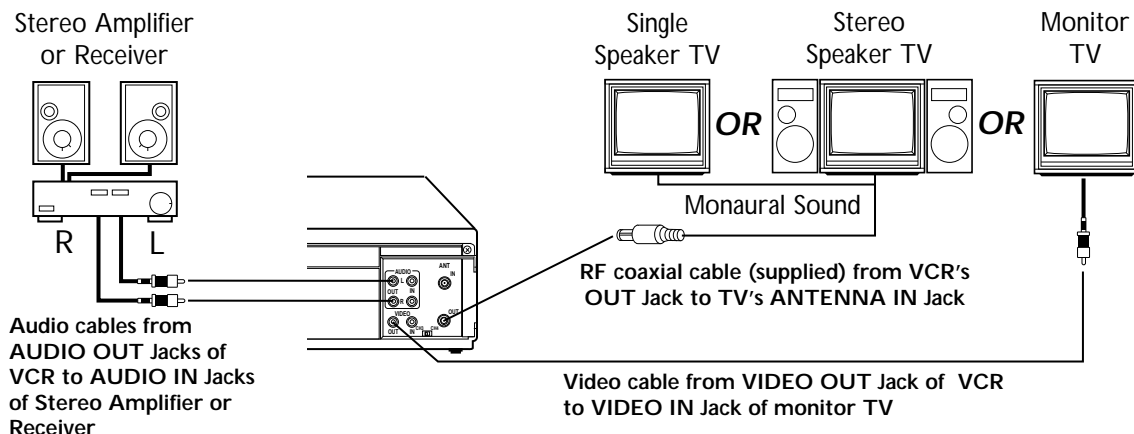

## 44 Multi-Channel Television Sound System (VRB612 only) (cont'd)

# 1

Press the VCR button, then press the MENU button.

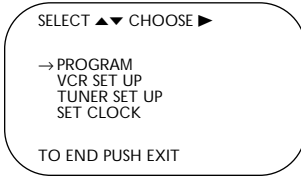

# 2

Press the PLAY/▲ button or the STOP/▼ button to select TUNER SET UP, then press the F.FWD/► button.

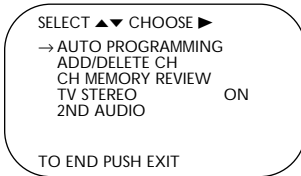

# 3

Press the PLAY/▲ button or the STOP/▼ button to select TV STEREO or 2ND AUDIO. Then, press the F.FWD/► button. ON will appear to the right of your selection.

# 4

Press the STATUS/EXIT button.

# 5

To record, select the channel to be recorded using the CH(annel) ▲/▼ button.

# 6

Press the REC(ord)/OTR button to start recording.

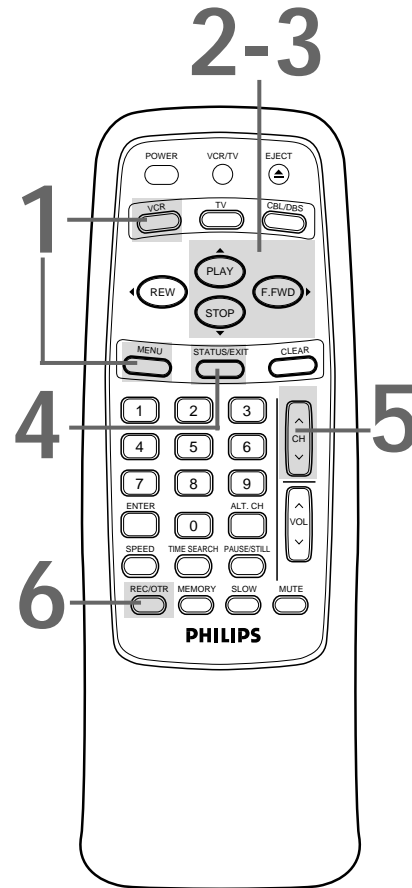

### Helpful Hints

- You can only receive and record in stereo or second audio programs that are broadcast in stereo or second audio. You can only play in stereo or second audio tapes that were recorded in stereo or second audio. Please see page 43 to determine if the program you want to watch/record is being broadcast in stereo or second audio.
- If you select second audio when second audio is not available, the VCR will record normal audio.

## Hi-Fi Stereo Sound System (VRB612 only) 45

Multi-Channel Television Sound system broadcasts are automatically recorded in Hi-Fi stereo sound. To play in Hi-Fi stereo the tapes recorded in Hi-Fi stereo, however, you'll need to follow steps 1-5.

# 1

Press the VCR button, then press the MENU button.

# 2

Press the PLAY/▲ button or the STOP/▼ button to select VCR SET UP, then press the F.FWD/▶ button.

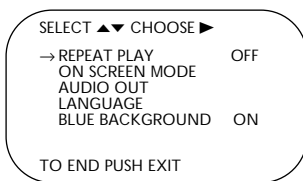

# 3

Press the PLAY/▲ button or the STOP/▼ button to select AUDIO OUT, then press the F.FWD/▶ button.

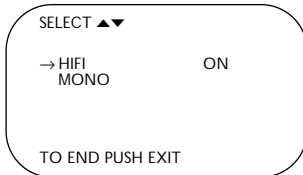

# 4

Press the PLAY/▲ button or the STOP/▼ button to select HIFI. ON will appear to the right of HIFI on the screen.

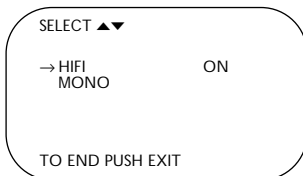

# 5

Press the STATUS/EXIT button.

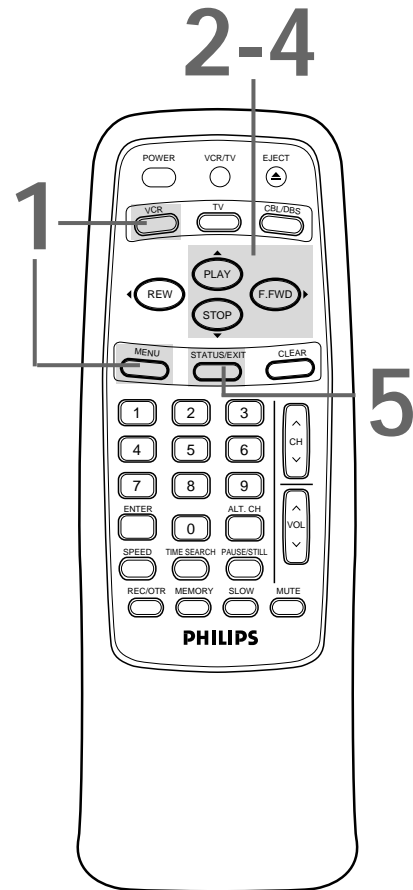

### Helpful Hints

- All programs are automatically recorded in both Hi-Fi stereo sound and in monaural sound.
  - The audio level of a tape recorded in Hi-Fi stereo will differ from the audio level of a tape not recorded in Hi-Fi stereo.
  - Normally, HIFI should be selected from the AUDIO OUT menu for playback with Hi-Fi sound. But, you can change the selection to MONO if you want monaural audio playback. To do this, follow steps 1-3. At step 4, press the PLAY/▲ button or the STOP/▼ button to select MONO. Press the STATUS/EXIT button. HIFI will disappear from the status display during TV viewing.
  - If you play non-Hi-Fi tapes while the VCR is set to HIFI, the tape will play in monaural sound.
- Please see additional notes on page 48.

## 46 Blue Background

If you want the TV screen to be solid blue when a weak signal is received, set BLUE BACKGROUND to ON. The screen will be blue and the sound will be muted.

Or, if you want to receive the weak signal, set BLUE BACKGROUND to OFF. When you select a channel that is receiving a weak signal, you will see and hear the static in the TV programming. The channel number will not appear on the screen when you select a weak channel.

To set BLUE BACKGROUND to ON or OFF, follow these steps.

# 1

Press the VCR button.

# 2

Press the MENU button.

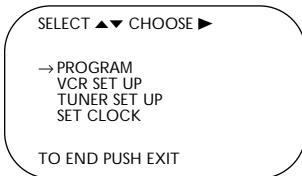

# 3

Press the PLAY/▲ button or the STOP/▼ button to select VCR SET UP, then press the F.FWD/► button.

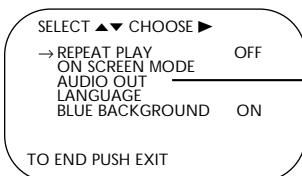

VRB612 only

# 4

Press the PLAY/▲ button or the STOP/▼ button to select BLUE BACKGROUND. Then, press the F.FWD/► button repeatedly so that OFF (or ON) appears beside BLUE BACKGROUND.

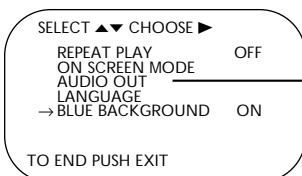

VRB612 only

# 5

Press the STATUS/EXIT button.

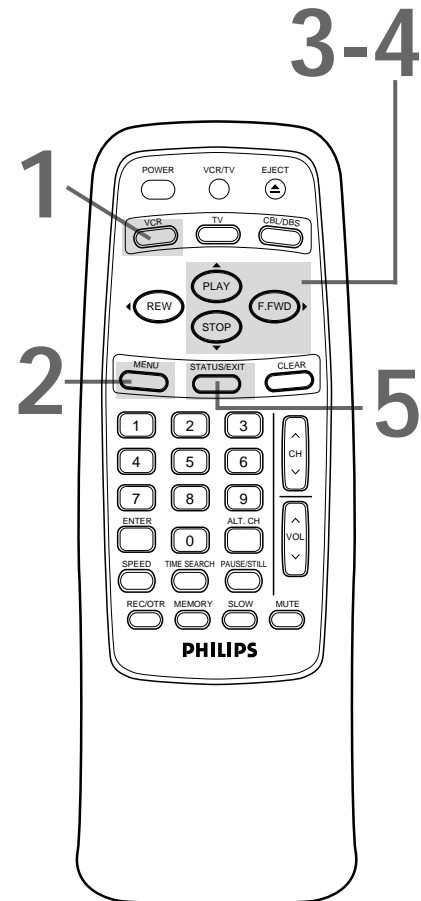

## Helpful Hints 47

---

If you are having problems with your product, check this list of problems and possible solutions before requesting service. You may be able to solve the problem yourself.

If you need to call a customer service representative, please know the model number and serial number of your product before you call. This information is displayed on the back of the product. Also, please take a moment to identify the problem you are having, and be prepared to explain this to the representative. If you believe the representative will need to help you with operations, please stay near the product. Our representatives will be happy to assist you.

### **No power**

- Make sure the power plug is completely connected to an AC (alternating current) outlet.
- Make sure the power is turned on.

### **Power Failure**

- Timer recordings and the clock setting may be lost if the power fails for more than one minute. See pages 15-16 to reset your clock if you set the clock manually. See pages 33-36 to reprogram your timer recordings.

### **A TV program cannot be recorded.**

- Check the connections between the VCR, TV, antenna/cable, and Cable Box/Direct Broadcast System (if applicable). *Details are on pages six-10.*
- Make sure the tape has a record tab. *Details are on page five.*
- Check the TV/VCR position. *Details are on page 27.*
- Check the CH3/CH4 switch. *Details are on pages six-nine.*

### **The VCR will not perform a timer recording.**

- Make sure the recording start and stop times are set correctly. *Details are on pages 33-36.*
- Make sure a tape is in the VCR and the tape has a record tab. *Details are on page five.* If, after programming a timer recording, you turn off the VCR power without putting a tape in the VCR, the Timer light will blink.
- If the record tab on a tape is missing, the VCR will eject the tape. The Timer light will blink.
- Make sure the VCR power is off.
- Make sure the clock is set. *Details are on pages 15-18.*
- The VCR may not perform or continue a timer recording if a power interruption of more than one minute occurs.
- If you have a Cable Box/Direct Broadcast System, timer recordings are programmed differently. *Details are on page eight.*
- Finish programming a timer recording at least five minutes before the recording is set to begin.
- 12 p.m. is noon; 12 a.m. is midnight.

### **There is no playback picture or the playback picture is noisy or contains streaks.**

- Make sure the TV is on the same channel as the VCR's CH3/CH4 switch.
- Make sure the VCR is in VCR position. (The VCR light will appear on the display panel.)
- Make sure channel 03 or 04 is properly adjusted at the TV.
- Adjust the tracking. *Details are on page 42.*
- TVs placed too close to the VCR can cause interference during tape playback. Move the VCR away from the TV.

### **The VCR cannot be controlled with the remote control.**

- Press the VCR button, then try the other VCR feature buttons.
- Make sure the VCR light appears on the display panel. If it does not, press the VCR/TV button once.
- Aim the remote control directly at the VCR's remote sensor. *Details are on page 27.*
- Remove all obstacles between the remote control and the VCR.
- Inspect and/or replace the batteries in the remote control. *Details are on page five.*

### **The Number buttons won't work for channels above 69.**

- Enter channel numbers as a two-digit number. If you want to select channels 100 and above, enter channel numbers as a three-digit number. *Details are on page 23.*

### **TV programs cannot be watched normally.**

- Put the VCR in TV position. (Press the VCR/TV button so that the VCR light disappears from the display panel.) *Details are on page 27.*
- Check the connections between the VCR, TV, antenna/cable, and Cable Box/Direct Broadcast System (if applicable). *Details are on pages six-10.*

## 48 Helpful Hints (cont'd)

---

### **Tape cannot be inserted.**

- Insert the tape, window side up, with the record tab facing you.
- Make sure a tape isn't already in the VCR by pressing the STOP/EJECT button on the VCR.
- Gently push on the center of the tape when putting it in the VCR. Never force the tape into the VCR.
- If a timer recording is programmed and the VCR power is off, you can not insert a tape without a record tab.

### **Tape cannot be removed.**

- Make sure the power plug is completely connected to a power outlet.
- You have set a timer recording. Turn the VCR power on, then eject the tape. Be sure to insert a tape and turn off the power for your timer recording.

### **VCR ejects the tape when the REC(ord)/OTR button is pressed or when the VCR power is turned off to set a timer recording.**

- Make sure the tape has a record tab. *Details are on page five.*

### **Poor reception**

- You may need to tune your TV again.

### **The motor (cylinder) rotates even when the VCR is in Stop mode.**

- To enable the quick play mechanism, the cylinder will rotate for about five minutes. This is normal. The quick play mechanism allows the tape mechanism to switch from Stop mode to Play mode in one second.

### **Direct Broadcast System Hookups**

- Watching one TV channel while recording another may not be possible if you have a DBS hookup. You may have to set your TV to channel 03 or 04, then make your channel selections at the DBS. *Details are on page nine.*
- With many DBS hookups, if you use accessory audio and video cables to connect your VCR to your TV, you will have to put your VCR in Line Input mode (channel 001 or 002).

### **Line Input mode**

- If you accidentally enter Line Input mode (AV FRONT or AV REAR will appear on your TV screen briefly), press the CH(annel) ▲/▼ button or use the Number buttons to select another channel.

### **Hi-Fi Stereo Sound (VRB612 only)**

- During playback, Hi-Fi audio may temporarily revert to normal audio when you adjust tracking. This is normal.
- When connecting the VCR to a stereo TV, you will only get stereo sound if you use audio cables to connect the AUDIO OUT jacks on the VCR to the AUDIO IN jacks on your TV, and if the TV is in Line (Auxiliary) Input mode.
- When you connect the AUDIO OUT jacks on the VCR to the AUDIO IN jacks on your TV, the stereo light on the TV might not glow. But, as long as the status display indicates you are receiving a stereo signal, you are receiving a stereo signal. This is normal.
- Only tapes recorded in Hi-Fi audio will play back in Hi-Fi audio. Tapes recorded in normal audio will play back in monaural audio.

### **Cleaning the Video Heads**

- Your VCR automatically cleans the video heads each time you insert a tape. However, the heads may become dirty. If so, use a commercially-available head cleaner or have an authorized servicer clean the video heads. Eventually, the heads may need to be replaced.

### **The playback picture is too dim, too bright, or fluctuates in brightness.**

- Some programs may be broadcast with copyright protection technology in order to protect the rights of copyright owners. This technology is used on programs that are recorded on video tapes or Digital Video Discs (DVDs), as well as some programs broadcast by antenna/cable/satellite television channels. Programs broadcast with copyright protection technology may not record clearly. Likewise, if you play a tape that is a recording of a copyright protected program, the picture may not be clear. Tapes of copyright protected programs may have a picture that is dark or dim, or the brightness of the picture may fluctuate. Therefore, you should avoid recording or playing copies of copyright protected programs. This VCR incorporates copyright protection technology that is protected by method claims of certain U.S. patents and other intellectual property rights owned by Macrovision Corporation and other rights owners. Use of this copyright protection technology must be authorized by Macrovision Corporation and is intended for home and other limited viewing uses only, unless otherwise authorized by Macrovision Corporation. Reverse engineering or disassembly is prohibited.



**AUDIO IN/OUT Jacks:** jacks located on the front and back of the VCR which are used to record audio from another source (IN) or to send audio to another system (OUT).

The VRB412 has a single AUDIO IN jack on the front and back of the VCR. It has a single AUDIO OUT jack on the back of the VCR. The VRB612 has Right and Left AUDIO IN jacks on the front and back of the VCR. It has Right and Left AUDIO OUT jacks on the back of the VCR.

**Automatic Channel Setup:** process in which the VCR memorizes all available channels. Then, when you press the CH(annel) ▲/▼ button, you only scan through channels you receive.

**Bands:** settings that allow you to tune channels.

- **Antenna** – VHF (very high frequency; channels 2-13) and UHF (ultra high frequency; channels 14-69).
- **Cable** – all standard channels can be received without a Cable Box.

**Cable Box/DBS Output Channel:** 03 or 04.

**Dubbing:** copying a tape using a second VCR.

**Frame:** a still picture.

**HQ:** high quality; a feature in the VCR circuitry which provides enhanced picture detail.

**Line Input:** The channel to which you set your VCR during dubbing. If you use the AUDIO and VIDEO In jacks on the front of the VCR, select channel 002 (AV FRONT). If you use the AUDIO and VIDEO IN jacks on the back of the VCR, select 001 (AV REAR). If you accidentally enter Line Input mode, press the CH(annel) ▲/▼ button or use the Number buttons to select another channel.

**OTR:** One-Touch Recording; a timed recording that starts immediately and records for 30 minutes to eight hours.

**Remote Control:** the small electronic unit that came with your VCR; allows you to operate your VCR from a distance. You may be able to operate your TV, Cable Box, or Direct Broadcast System with the remote control.

**RF coaxial cable:** The cable supplied with your VCR. Use it to connect your VCR to your TV (or Cable Box or DBS). The supplied cable is a snap-on type. However, you may use a screw-on type if you prefer.

**Special Effects:** forward and reverse searching; a still picture; slow motion playback.

**Tape Speeds:** how fast the tape travels during a recording or playback.

- **SP** (standard play) – fastest tape speed (recording time for a T120 tape is approximately two hours); best picture quality.
- **LP** (long play) – average tape speed; playback only.
- **SLP** (super long play) – slowest tape speed (recording time for a T120 tape is approximately six hours).

**VCR:** video cassette recorder.

**VIDEO IN/OUT Jacks:** jacks located on the front and back of the VCR which are used to record video from another source (IN) or to send video to another system (OUT).

## 50 Specifications

---

### **Video Heads**

Four heads – Hi-Fi (VRB612)

Four heads (VRB412)

### **Video Signal**

EIA standards; NTSC color

### **Antenna**

VHF/UHF – 75 ohm external antenna terminal

### **VHF Output Signal**

Channel 03 or 04 (switchable)

75 ohms unbalanced

### **Power Requirement**

120V AC; 60Hz

### **Power Consumption**

14W (VRB612)

12W (VRB412)

### **Operating Temperature**

41°F (5°C) to 104°F (40°C)

### **Relative Humidity**

10% to 80%

### **Weight**

5.5 lbs. (2.5 kg.) (VRB612)

5.3 lbs. (2.4 kg.) (VRB412)

### **Dimensions**

14-3/16" (W) x 3-5/8" (H) x 8-3/4" (D)

(360mm x 92mm x 223mm)

### **Tuner Broadcast Channels**

VHF 2-13, UHF 14-69

### **Cable TV Channels**

1-125

*NOTE: Designs and specifications are subject to change without notice.*

**RENEWED  
90 DAY  
LIMITED WARRANTY**

## 52 Index

- ac power cord.....28
- accessories .....56
- alt.ch button.....24
- ant(enna) in jack.....6-10, 28
- audio in/out jacks.....10, 27,  
.....28, 37, 43 49
- automatic
  - playback.....42
  - rewind, eject, off.....42
- batteries .....5
- blue background.....46
- cassette compartment.....26
- cassette-inside light .....26
- cbi/dbi button.....5, 22, 24
- ch(annel) ▲/▼ button .....24
- ch3/ch4 switch.....6-9, 28
- channel
  - adding.....13
  - deleting.....13
  - reviewing.....14
  - selection.....23
  - setup.....11-14
  - ▲/▼ buttons.....27, 42
- clear button.....24, 39
- clock display.....26
- clock setting.....15-19
- connections.....6-10
- contents, table of.....4
- controls
  - remote.....23-24
  - vcr.....26-28
- copyright protection.....37, 48
- counter only mode.....25
- daylight-savings time.....19
- display panel.....26
- duplication.....37
- eject button.....23
- enter button.....21-22, 24
- f.fwd/▶ button.....24, 27, 41
- front panel.....27
- glossary.....49
- head cleaner.....3, 5, 48, 51
- helpful hints.....47-48
- hi-fi stereo sound system.....45
- hookups
  - with cable box/dbi.....8-9
  - with stereo tv.....10
  - without cable box/dbi.....6-7
- language selection.....11, 20
- line input mode.....12, 37, 49
- long play.....35, 49
- lp.....35, 49
- memory button.....23, 39
- menu button.....23, 27
- mute button.....23
- number buttons.....23
- on-screen status displays.....25
- one-touch recording.....32
- out jack.....6-9, 28
- pause button.....27
- pause/still button.....23, 30, 41
- play/▲ button.....23, 27, 29, 41
- playing.....29
- power
  - button.....23, 27
  - cord.....28
- pwr.(power) light.....26
- real-time counter.....39
- rear panel.....28
- rec/otr button.....23, 27, 30, 32
- rec(ord) light.....26
- recording
  - basic.....30
  - one channel/  
watching another.....31
  - prevention.....5
  - timer.....33-36
- remote control
  - buttons.....23-24
  - sensor.....27
  - using.....5
- repeat play.....38
- rerecording.....37
- rew(ind)/◀ button.....24, 27, 41
- rf coaxial cable.....6-9, 37, 49
- safety precautions.....3
- searching.....41
- second audio broadcast
  - receiving.....43-44
  - recording.....43-44
- sensor (remote).....27
- slow
  - button.....23
  - motion.....41
- slp.....35, 49
- sp.....35, 49
- speed button.....23
- sqpb.....29
- standard play.....35, 49
- status display.....25
- status/exit button.....24, 25, 27
- stereo
  - broadcast
    - receiving.....43-44
    - recording.....43-44
  - hookups.....43
- stereo TV hookups.....10
- still picture.....41
- stop/▼ button.....24
- stop/eject button.....27
- super high speed searching.....41
- super long play.....35, 49
- table of contents.....4
- tape
  - duplication.....37
  - eject.....23, 27, 42
  - speed.....35, 49
- time
  - search button.....24, 40
  - setting.....15-19
- timer
  - light.....26
  - recording
    - cancelling.....36
    - checking.....36
    - setting.....33-35
- tracking.....42
- tv
  - button.....5, 21, 24
  - controls.....5, 21, 23-24
  - hookups.....6-10
  - position.....24, 27
- vcr
  - button.....5, 23
  - light.....26
  - position.....24, 27
- vcr/tv button.....24, 27
- video in/out jacks.....10, 27, 28,  
.....37, 43, 49
- vol(ume) ▲/▼ button.....23
- warranty.....51







# SUPPLIED ACCESSORIES

*The following items are supplied with your VCR; they are provided to help you use or set up your VCR.*

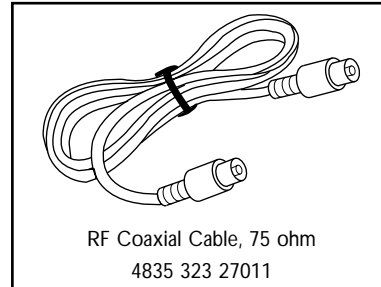
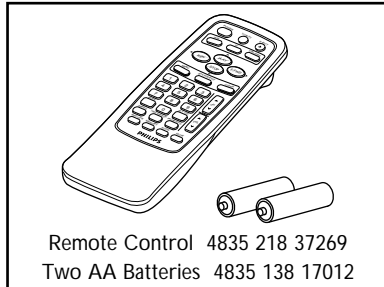

# OPTIONAL ACCESSORIES

*The following additional items are not provided with your VCR, but they are designed for use with your new VCR. To order these optional accessories, contact us at:*

**Philips Parts & Accessories Marketing Department**  
401 East Old Andrew Johnson Highway  
P.O. Box 555  
Jefferson City, TN 37760  
1-800-851-8885.

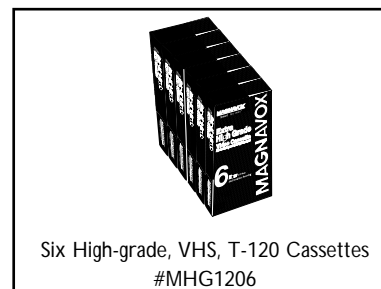
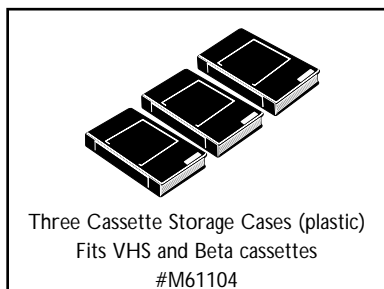
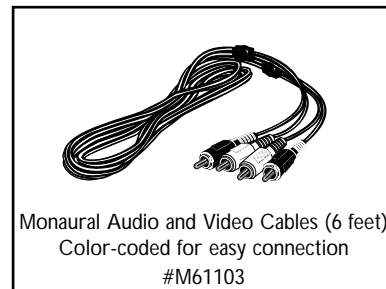
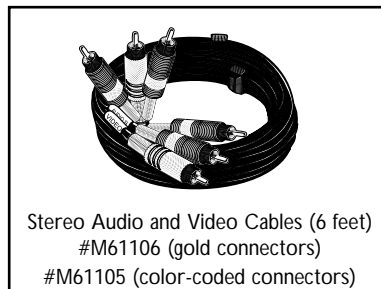

This owner's manual is made of recyclable materials.  
Remember to recycle!



As an ENERGY STAR® Partner, Philips Consumer Electronics Company has determined that this product meets the ENERGY STAR® guidelines for energy efficiency. ENERGY STAR® is a U.S. registered mark.

IB8194E001  
Printed In China  
OVMN02436 / H59S0UD \* \* \* \* \*